

DVM

Technical Data Book

DVM S Eco 8, 9 HP

SAMSUNG

Nomenclature

Outdoor units

Model Name

AM

(1)

080

(2)

F

(3)

X

(4)

V

(5)

A

(6)

G

(7)

H

(8)

/

EU

Buyer

(1) Classification

AM	DVM
----	-----

(5) Feature1

V	Inverter
---	----------

(2) Capacity

x 1/10 HP (3 digits)

(6) Feature2

A	Standard + General Temp.+
---	---------------------------

(3) Version

E	2012
F	2013
G	2014

(7) Rating Voltage

E	1Ø, 220~240V, 50Hz
G	3Ø, 380~415V, 50Hz



















(4) Product Type









X	Outdoor Unit
N	Indoor Unit









(8) Mode

H	Heat Pump
R	Heat Recovery

Accessory

Classification		Product	Model	Image	Application model
Building management system		DMS-Bnet (BACnet)	MIM-B17N		DVM S
		Lonworks interface module	MIM-B18N		DVM S
Centralized control system	Controller	Centraized controller	MCM-A202DN		DVM S
		New touch CONTROLLER	MCM-A300N		DVM S
		Operation mode selection switch	MCM-C200		DVM S
Converter		S-Net Pro	MIM-C02N		DVM S
		Communication	MIM-N00		DVM S (Nasa-No Nasa)
		Communication	MIM-N01		DVM S (Nasa-No Nasa, No Nasa-Nasa)
Guest room management system		External contact interface module	MIM-B14		DVM S
Individual control system controller	Controller	ERV CO2 Sensor	MOS-C1		ERV, ERV PLUS
		Wireless remote controller	MR-DH00		Cassette, Duct(Receiver needed)
		Wireless signal receiver	MRK-A10N		Duct (For wireless remote controller)
		Remote sensor	MRW-TA		Cassette, Wall-mounted, Ceiling, Duct, Console
		Wired remote controller (Multi function)	MWR-WE10N		Cassette, Wall-mounted, Ceiling, Duct, Console, ERV
		Wired remote controller	MWR-WW00N		Hydro Unit
Integrated management system	Controller	DMS 2	MIM-D00AN		DVM S
		S-NET3	MST-P3P		DVM S
	Interface Module	PIM	MIM-B16N		DVM S (latter half of 2013)
Multi Tenant Function Controller			MCM-C210		DVM S

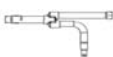
Classification	Feature	Model	Description	Relevant unit	Remark
AHU KIT		MXD-K025AN	7.0kW ~ 8.75kW	-	Option
		MXD-K050AN	14.0kW ~ 17.5kW	-	Option
		MXD-K075AN	21.0kW ~ 26.25kW	-	Option
		MXD-K100AN	28.0kW ~ 35.0kW	-	Option
Drain Pump		MDP-E075SEE3D	SlimDuct(2.0~14.0)kW	-	Option
		MDP-M075SGU1D	MSP Duct(9.0/11.2)kW	-	Option
		MDP-M075SGU2D	MSP Duct(12.8/14.0)kW	-	Option
		MDP-M075SGU3D	MSP Duct(5.6/7.1)kW	-	Option
		MDP-N047SNC1D	HSP Duct 22.0/28.0kW	-	Option
EEV kits		MEV-E24SA	1 Indoor	Apply to products without EEV(Wall mount & Ceiling)	Option
		MEV-E32SA	1 Indoor	Apply to products without EEV(Wall mount & Ceiling)	Option
		MXD-E24K132A	2 Indoor	Apply to products without EEV(Wall mount & Ceiling)	Option
		MXD-E24K200A	2 Indoor	Apply to products without EEV(Wall mount & Ceiling)	Option
		MXD-E24K232A	3 Indoor	Apply to products without EEV(Wall mount & Ceiling)	Option
		MXD-E24K300A	3 Indoor	Apply to products without EEV(Wall mount & Ceiling)	Option
		MXD-E32K200A	2 Indoor	Apply to products without EEV(Wall mount & Ceiling)	Option
		MXD-E32K224A	3 Indoor	Apply to products without EEV(Wall mount & Ceiling)	Option
		MXD-E32K300A	3 Indoor	Apply to products without EEV(Wall mount & Ceiling)	Option
Front Panel		PC1NUPMAN	Slim 1way cassette (Z-slide)	-	Requisite
		PC1NUSMAN	Slim 1way cassette	-	Requisite

Classification	Feature	Model	Description	Relevant unit	Remark
Front Panel		PC4NBSKAN	4 way cassette (Waffle, Black)	-	Requisite
		PC4NUSKAN	4 way cassette (Waffle)	-	Requisite
		PC4NUSKEN	4 way cassette (Classic)	-	Requisite
		PC4SUSMAN	4 way cassette (600 x 600) (Waffle)	-	Requisite
		PC4SUSMBN	4 way cassette (600 x 600) (Classic)	-	Requisite
Header joint		MXJ-HA2512M	45.0 kW and below (for 4 rooms)	DVM S HP/HR	Requisite
		MXJ-HA3115M	70.3 kW and below (for 8 rooms)	DVM S HP/HR	Requisite
		MXJ-HA3819M	Over 70.3 kW (for 8 rooms)	DVM S HP/HR	Requisite
Humidifier		MVO-VA050100	500CMH	-	Option
		MVO-VA100100	1000CMH	-	Option
MCU		MCU-S4NEE1N	Below 4 indoor units	DVM S HR	Requisite(H R Only)
		MCU-S4NEE2N	Below 2 large capacity ducts	DVM S HR	Requisite(H R Only)
		MCU-S6NEE1N	Below 6 indoor units	DVM S HR	Requisite(H R Only)
Motion Detect Sensor		MCR-SMA	4 way cassette (600 x 600)	-	Option
Outdoor joint(High Pressure Gas) for DVM S HR		MXJ-TA3100M	135.2kW and below	DVM S HR	Requisite
		MXJ-TA3800M	Over 140.2kW	DVM S	Requisite
Outdoor joint(Outdoor Connection)		MXJ-TA3819M	135.2kW and below	DVM S HP/HR	Requisite
		MXJ-TA4422M	Over 140.2kW	DVM S HP/HR	Requisite
PDM KIT		MXD-A12K2A	14~16HP	DVM S	Option
		MXD-A38K2A	8~12HP	DVM S	Option

Classification	Feature	Model	Description	Relevant unit	Remark
Virus Doctor KIT		MSD-CAN1	4way Cassette	-	Option
		MSD-EAN1	ERV-Plus	-	OPtion
Y-JOINT		MXJ-YA1509M	15.0 kW and below	DVM S HP / HR	Requisite
		MXJ-YA2512M	Over 15.0 kW~40.0 kW and below	DVM S HP/HR	Requisite
		MXJ-YA2812M	Over 40.0 kW~45.0 kW and below	DVM S HP/HR	Requisite
		MXJ-YA2815M	Over 45.0 kW~70.3 kW and below	DVM S HP/HR	Requisite
		MXJ-YA3419M	Over 70.3 kW~98.4 kW and below	DVM S HP/HR	Requisite
		MXJ-YA4119M	Over 98.4 kW~135.2 kW and below	DVM S HP/HR	Requisite
		MXJ-YA4422M	Over 135.2 kW	DVM S HP/HR	Requisite
Y-joint(High Pressure Gas) for DVM S HR		MXJ-YA1500M	22.4 kW and below	DVM S HR	Requisite
		MXJ-YA2500M	Over 22.4 kW~70.3 kW and below	DVM S HR	Requisite
		MXJ-YA3100M	Over 70.3 kW~135.2 kW and below	DVM S HR	Requisite
		MXJ-YA3800M	Over 135.2 kW	DVM S HR	Requisite

Outdoor

1 Line-up

2 Specifications

3 Dimensional drawing

4 Electrical wiring diagram

5 Sound pressure level

6 Cycle Diagram

1 Line-up

Outdoor Unit

Model	AM080FXMDGH/EU	AM090FXMDGH/EU
AM080FXMDGH/EU	1	
AM090FXMDGH/EU		1

2 Specifications

Outdoor

Type			DVM S Eco(NEW)	DVM S Eco(NEW)	
Model Name			AM080FXMDGH/EU	AM090FXMDGH/EU	
Power Supply		Ø, #, V, Hz	3,4,380-415,50	3,4,380-415,50	
Mode			Heat Pump	Heat Pump	
Performance	HP	Cooling	HP	8.00	9.00
			kW	22.40	24.10
	Capacity (Nominal)	Heating	Btu/h	76,400	82,200
			kW	25.00	26.00
		Btu/h	85,300	88,700	
Power	Power Input (Nominal)	Cooling 1)	kW	5.72	6.90
		Heating 2)	kW	4.88	5.34
	Current Input (Nominal)	Cooling 1)	A	9.66	11.65
		Heating 2)	A	8.24	9.01
	MCA	A	18.00 (MCA)	18.00 (MCA)	
	MFA	A	25.00	25.00	
COP	EER (Nominal Cooling)		-	3.92	3.49
	COP (Nominal Heating)		-	5.12	4.87
	Energy Grade		-	-	-
			-	-	-
Compressor	Type		-	SSC Scroll	SSC Scroll
	Output		kW x n	4.96	4.96
	Model Name		-	DS-GB052FAVADO	DS-GB052FAVADO
	Oil	Type	-	PVE	PVE
Fan	Type		-	Propeller	Propeller
	Output x n		W	180 x 2	180 x 2
	Air Flow Rate		CMM	135	145
			l/s	2,250.00	2,416.67
	External Static Pressure	Max.	mmAQ	-	-
Pa			-	-	
Piping Connections	Liquid Pipe		Ø, mm	9.52	9.52
			Ø, inch	3/8"	3/8"
	Gas Pipe		Ø, mm	19.05	19.05
			Ø, inch	3/4"	3/4"
	Discharge Gas Pipe		Ø, mm	-	-
			Ø, inch	-	-
	Installation Limitation	Max. Length	m	100 (100)	100 (100)
Max. Height		m	30 (30)	30 (30)	
Field Wiring	Power Source Wire		mm ²	-	-
	Transmission Cable		mm ²	0.75 ~ 1.50	0.75 ~ 1.50
Refrigerant	Type		-	R410A	R410A
	Factory Charging		kg	3.70	3.70
Sound	Pressure		dBA	56.0	57.0
	Power			74.0	76.0
External Dimension	New Weight		kg	135.0	135.0
	Shipping Weight		kg	145.0	145.0
	Net Dimensions (WxHxD)		mm	940 x 1,420 x 330	940 x 1,420 x 330
	Shipping Dimensions (WxHxD)		mm	995 x 1,578 x 426	995 x 1,578 x 426
Operating Temp.	Cooling		°C	-5.0 ~ 48.0	-5.0 ~ 48.0
	Heating		°C	-20.0 ~ 24.0	-20.0 ~ 24.0

1) Nominal cooling capacities are based on;

Indoor temperature : 27°C DB, 19°C WB / Outdoor temperature : 35°C DB, Equivalent refrigerant piping : 7.5m , Level differences : 0m

2) Nominal heating capacities are based on;

Indoor temperature : 20°C DB, 15°C WB / Outdoor temperature : 7°C DB, 6°C WB, Equivalent refrigerant piping : 7.5m, Level differences : 0m

3) Sound level was acquired in an anechoic room. Thus actual noise level may be different depending on the installation conditions.

3 Dimensional drawing

Outdoor

AM080FXMDGH/EU,AM090FXMDGH/EU

Units : mm / inches

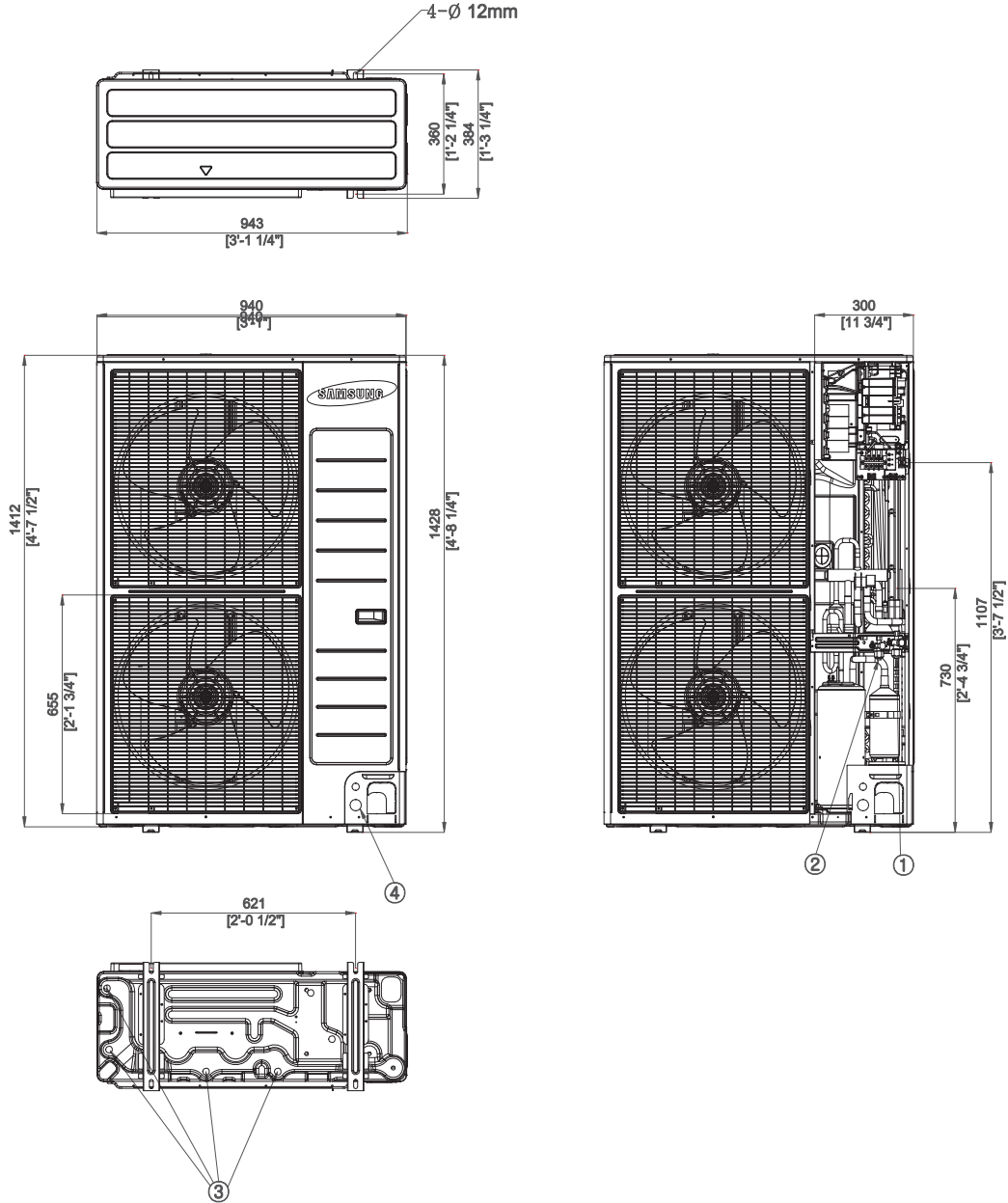
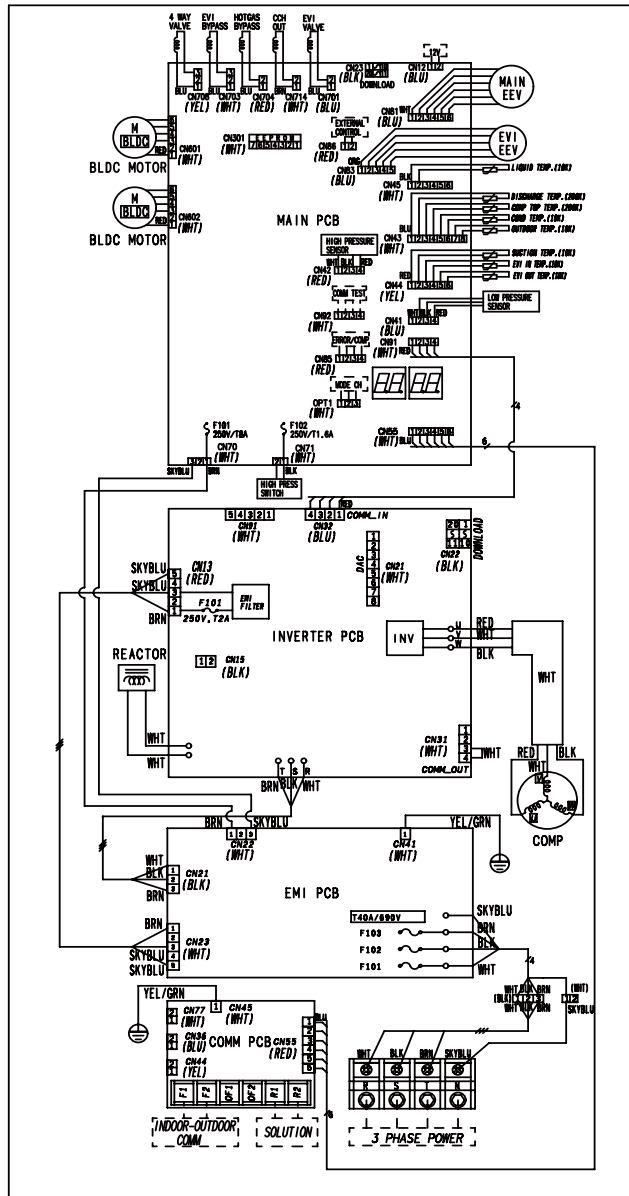

Table of descriptions

1	Refrigerant gas pipe	7	
2	Refrigerant liquid pipe	8	
3	Drain Hole	9	
4	Power & Comm. wiring conduits	10	
5		11	
6		12	

4 Electrical wiring diagram

Outdoor
AM080FXMDGH/EU



5 Sound pressure level

Outdoor

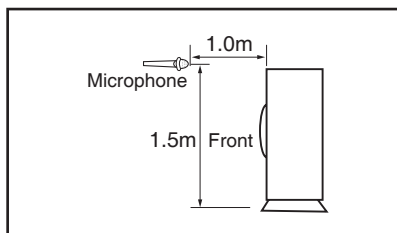

Unit: dB(A)	
Model	Pressure
AM080FXMDGH/EU	56.0
AM090FXMDGH/EU	57.0

Note

Measuring place: Anechoic chamber (conversion value)

These operation values were obtained in an anechoic room. Sound pressure level will vary depending on a factors such as the construction of the particular room where the equipment is installed.

Operation sound level may differ depending on operation and ambient conditions.

NC curves

1) AM080FXMDGH/EU

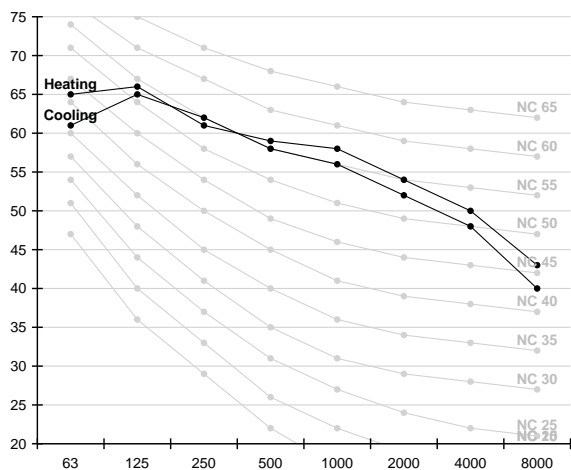

2) AM090FXMDGH/EU

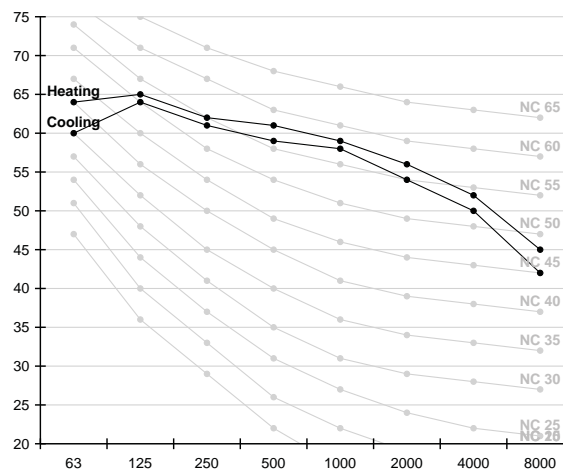

6 Cycle Diagram

Outdoor

AM080FXMDGH/EU,AM090FXMDGH/EU

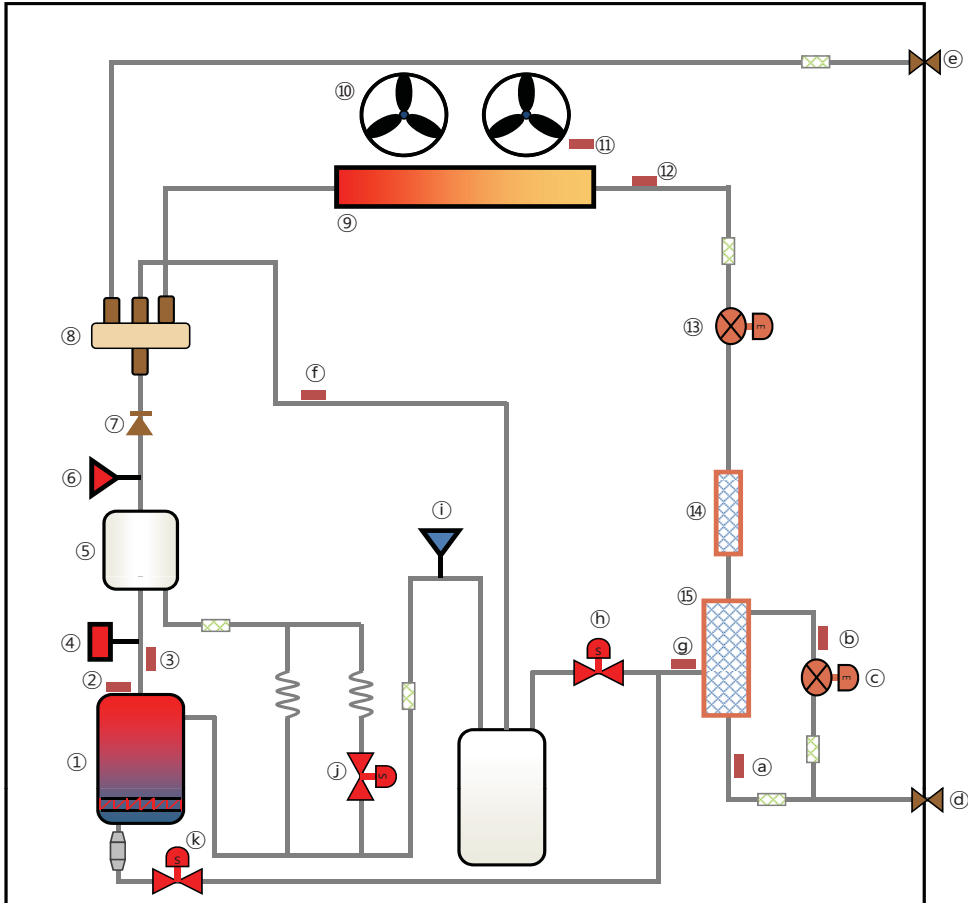

1	Compressor	14	IPM
2	Sensor on the compressor	15	PHE (Plate Heat Exchanger)
3	Discharge temperature sensor	a	Subcool temperature sensor
4	High pressure switch	b	EVI inlet temperature sensor
5	Oil separator	c	EVI EEV
6	High pressure sensor	d	Service valve (Liquid)
7	Check valve	e	Service valve (Gas)
8	Reversing valve	f	Suction temperature sensor
9	Condenser	g	EVI outlet temperature sensor
10	Fan & motor	h	EVI solenoid valve
11	Ambient temperature sensor	i	Low pressure sensor
12	Cond. outlet temperature sensor	j	Hot gas bypass solenoid valve
13	EEV	k	Oil return solenoid valve

DVM Capacity

1 Capacity table

2 Capacity correction

Capacity table

AM080FXMDGH/EU

Cooling

TC : Total Capacity, PI : Power Input

Combination, % (Capacity index)	Outdoor Temperature (°C, DB)	Indoor Temperature (°C, WB)													
		14		16		18		19		20		22		24	
		TC	PI	TC	PI	TC	PI	TC	PI	TC	PI	TC	PI	TC	PI
130	10	19.30	2.53	24.10	3.26	26.80	3.57	28.50	3.96	28.20	4.14	29.40	4.26	30.50	4.28
	12	19.30	2.55	24.10	3.29	26.80	3.59	28.20	3.95	28.00	4.13	29.20	4.25	30.20	4.27
	14	19.30	2.59	24.10	3.34	26.80	3.65	27.90	3.97	27.70	4.15	28.90	4.27	29.90	4.29
	16	19.30	2.66	24.10	3.43	26.60	3.75	27.60	4.03	27.40	4.21	28.50	4.34	29.60	4.36
	18	19.30	2.77	24.10	3.57	26.30	3.87	27.20	4.15	27.00	4.33	28.10	4.46	29.20	4.48
	20	19.30	2.92	24.10	3.77	25.90	4.03	26.90	4.32	26.60	4.51	27.80	4.64	28.80	4.67
	21	19.30	3.02	24.10	3.89	25.70	4.13	26.70	4.43	26.50	4.62	27.60	4.76	28.60	4.78
	23	19.30	3.24	24.10	4.17	25.40	4.37	26.30	4.68	26.10	4.90	27.20	5.04	28.20	5.06
	25	19.30	3.50	23.80	4.51	25.10	4.66	26.00	5.00	25.80	5.22	26.90	5.37	27.80	5.40
	27	19.30	3.79	23.50	4.89	24.80	4.99	25.70	5.35	25.50	5.59	26.50	5.75	27.50	5.78
	29	19.30	4.11	23.20	5.30	24.50	5.34	25.40	5.73	25.10	5.98	26.20	6.16	27.20	6.19
	31	19.30	4.44	22.90	5.72	24.10	5.70	25.10	6.11	24.80	6.38	25.90	6.57	26.80	6.61
	33	19.20	4.76	22.60	6.15	23.80	6.04	24.70	6.47	24.50	6.76	25.50	6.96	26.50	7.00
	35	19.00	5.07	22.30	6.54	23.50	6.33	24.30	6.79	24.10	7.09	25.10	7.30	26.10	7.34
	37	18.60	5.34	21.90	6.89	23.00	6.55	23.90	7.02	23.70	7.33	24.70	7.54	25.60	7.58
	39	18.20	5.54	21.40	6.99	22.50	6.65	23.40	7.12	23.20	7.44	24.10	7.66	25.00	7.70
	42	17.40	5.60	20.40	6.82	21.50	6.48	22.30	6.95	22.10	7.26	23.10	7.47	23.90	7.51
	44	16.60	5.27	19.60	6.42	20.60	6.10	21.40	6.54	21.20	6.83	22.10	7.03	22.90	7.07
120	10	18.00	2.25	21.70	2.82	25.10	3.08	26.90	3.58	27.80	3.91	29.00	4.02	29.70	4.04
	12	18.00	2.26	21.70	2.84	25.10	3.10	26.90	3.60	27.60	3.90	28.70	4.01	29.50	4.03
	14	18.00	2.32	21.70	2.91	25.10	3.18	26.90	3.70	27.30	3.96	28.40	4.07	29.20	4.10
	16	18.00	2.39	21.70	2.99	25.10	3.27	26.90	3.80	27.00	4.02	28.10	4.14	28.80	4.16
	18	18.00	2.49	21.70	3.11	25.10	3.41	26.80	3.95	26.60	4.13	27.70	4.25	28.40	4.28
	20	18.00	2.63	21.70	3.29	25.10	3.60	26.50	4.12	26.20	4.30	27.40	4.43	28.10	4.45
	21	18.00	2.71	21.70	3.39	25.10	3.71	26.30	4.22	26.10	4.41	27.20	4.54	27.90	4.56
	23	18.00	2.91	21.70	3.64	25.10	3.98	26.00	4.47	25.70	4.67	26.80	4.81	27.50	4.83
	25	18.00	3.14	21.70	3.93	25.10	4.30	25.60	4.76	25.40	4.98	26.50	5.12	27.10	5.15
	27	18.00	3.40	21.70	4.26	24.90	4.66	25.30	5.10	25.10	5.33	26.10	5.49	26.80	5.51
	29	18.00	3.69	21.70	4.62	24.60	5.05	25.00	5.46	24.80	5.71	25.80	5.87	26.50	5.90
	31	18.00	3.99	21.70	4.99	24.30	5.44	24.70	5.83	24.50	6.09	25.50	6.27	26.20	6.30
	33	18.00	4.28	21.70	5.36	23.90	5.76	24.40	6.17	24.10	6.45	25.20	6.64	25.80	6.67
	35	18.00	4.56	21.50	5.70	23.60	6.04	24.00	6.47	23.80	6.76	24.80	6.96	25.40	7.00
	37	17.70	4.80	21.20	6.00	23.20	6.25	23.60	6.69	23.30	6.99	24.30	7.20	25.00	7.23
	39	17.30	4.98	20.70	6.23	22.60	6.34	23.00	6.79	22.80	7.10	23.80	7.30	24.40	7.34
	42	16.50	4.94	19.80	6.26	21.60	6.18	22.00	6.62	21.80	6.92	22.70	7.12	23.30	7.16
	44	15.80	4.65	18.90	5.89	20.70	5.82	21.10	6.23	20.90	6.51	21.80	6.70	22.30	6.74
110	10	16.60	1.95	20.50	2.46	23.00	2.70	24.60	3.13	26.10	3.50	28.20	3.74	29.00	3.76
	12	16.60	1.97	20.50	2.48	23.00	2.71	24.60	3.15	26.10	3.52	28.20	3.74	28.80	3.76
	14	16.60	2.02	20.50	2.54	23.00	2.78	24.60	3.23	26.10	3.61	28.10	3.79	28.50	3.81
	16	16.60	2.07	20.50	2.61	23.00	2.86	24.60	3.32	26.10	3.71	27.70	3.85	28.10	3.87
	18	16.60	2.16	20.50	2.72	23.00	2.98	24.60	3.46	26.10	3.85	27.30	3.96	27.80	3.98
	20	16.60	2.28	20.50	2.87	23.00	3.15	24.60	3.65	26.10	4.01	27.00	4.12	27.40	4.15
	21	16.60	2.35	20.50	2.97	23.00	3.25	24.60	3.76	26.00	4.11	26.80	4.23	27.20	4.25
	23	16.60	2.52	20.50	3.18	23.00	3.48	24.60	4.04	25.60	4.35	26.40	4.47	26.80	4.50
	25	16.60	2.73	20.50	3.44	23.00	3.76	24.60	4.36	25.30	4.64	26.10	4.77	26.50	4.80
	27	16.60	2.96	20.50	3.73	23.00	4.08	24.60	4.73	25.00	4.96	25.80	5.11	26.20	5.13
	29	16.60	3.20	20.50	4.04	23.00	4.42	24.40	5.09	24.70	5.31	25.50	5.47	25.90	5.50
	31	16.60	3.46	20.50	4.36	23.00	4.78	24.10	5.43	24.40	5.67	25.10	5.83	25.50	5.87
	33	16.60	3.72	20.50	4.68	23.00	5.13	23.80	5.75	24.10	6.01	24.80	6.18	25.20	6.21
	35	16.60	3.96	20.50	4.99	23.00	5.46	23.40	6.03	23.70	6.30	24.40	6.48	24.80	6.52
	37	16.30	4.09	20.10	5.25	22.60	5.75	23.00	6.23	23.30	6.51	24.00	6.70	24.40	6.74
	39	15.90	4.15	19.60	5.45	22.10	5.90	22.50	6.32	22.80	6.61	23.50	6.80	23.80	6.84
	42	15.20	4.05	18.80	5.36	21.10	5.76	21.50	6.17	21.70	6.45	22.40	6.63	22.70	6.67
	44	14.60	3.81	18.00	5.04	20.20	5.42	20.60	5.80	20.80	6.06	21.50	6.24	21.80	6.27
100	10	15.90	1.70	18.60	2.16	21.40	2.66	22.40	2.85	24.30	3.13	26.20	3.38	28.10	3.55
	12	15.90	1.71	18.60	2.17	21.40	2.68	22.40	2.87	24.30	3.15	26.20	3.40	28.10	3.57
	14	15.90	1.74	18.60	2.20	21.40	2.72	22.40	2.92	24.30	3.20	26.20	3.45	28.10	3.62
	16	15.90	1.79	18.60	2.26	21.40	2.80	22.40	3.00	24.30	3.29	26.20	3.55	27.70	3.68
	18	15.90	1.86	18.60	2.36	21.40	2.92	22.40	3.12	24.30	3.43	26.20	3.69	27.40	3.78
	20	15.90	1.97	18.60	2.49	21.40	3.08	22.40	3.30	24.30	3.62	26.20	3.90	27.00	3.93
	21	15.90	2.03	18.60	2.57	21.40	3.18	22.40	3.40	24.30	3.73	26.20	4.01	26.80	4.03
	23	15.90	2.18	18.60	2.76	21.40	3.41	22.40	3.65	24.30	4.00	25.80	4.25	26.50	4.27
	25	15.90	2.35	18.60	2.98	21.40	3.68	22.40	3.94	24.30	4.33	25.50	4.53	26.10	4.55
	27	15.90	2.55	18.60	3.23	21.40	3.99	22.40	4.27	24.30	4.69	25.20	4.85	25.80	4.87
	29	15.90	2.76	18.60	3.50	21.40	4.32	22.40	4.63	24.10	5.04	24.90	5.19	25.50	5.22
	31	15.90	2.99	18.60	3.78	21.40	4.67	22.40	5.00	23.80	5.38	24.50	5.54	25.20	5.57
	33	15.90	3.21	18.60	4.06	21.40	5.02	22.40	5.37	23.50	5.70	24.20	5.87	24.80	5.90
	35	15.90	3.41	18.60	4.32	21.40	5.34	22.40	5.72	23.10	5.98	23.90	6.15	24.50	6.18
	37	15.60	3.53	18.30	4.47	21.00	5.52	22.00	5.91	22.70	6.18	23.40	6.36	24.00	6.39
	39	15.20	3.58	17.90	4.53	20.50	5.60	21.50	6.00	22.20	6.27	22.90	6.45	23.50	6.49
	42	14.50	3.49	17.10	4.42	19.60	5.46	20.50	5.85	21.20	6.12	21.90	6.30	22.40	6.33
	44	13.90	3.29	16.40	4.16	18.80	5.14	19.70	5.51	20.30	5.76	20.90	5.92	21.50	5.96
90	10	14.70	1.36	17.30	1.72	19.90	2.13	20.80	2.28	22.00	2.44	23.80	2.84	26.00	2.98
	12	14.70	1.37	17.30	1.73	19.90	2.14	20.80	2.29	22.00	2.45	23.80	2.86	26.00	3.00
	14	14.70	1.39	17.30	1.76	19.90	2.18	20.80	2.33	22.00	2.49	23.80	2.90	26.00	3.05
	16	14.70	1.43	17.30	1.81	19.90	2.24	20.80	2.40	22.00	2.56	23.80	2.98	26.00	3.13
	18	14.70	1.49	17.30	1.88	19.90	2.33	20.80	2.50	22.00	2.67	23.80	3.11	26.00	3.26
	20	14.70	1.57	17.30	1.99	19.90	2.46	20.80	2.63	22.00	2.82	23.80	3.28	25.60	3.44
	21	14.70	1.62	17.30	2.05	19.90	2.54	20.80	2.72	22.00	2.91	23.80	3.39	25.40	3.54
	23	14.70	1.74	17.30	2.20	19.90	2.72	20.80	2.92	22.00	3.12	23.80	3.63	25.10	3.75

Capacity table

AM080FXMDGH/EU

Cooling

TC : Total Capacity, PI : Power Input

Combination, % (Capacity index)	Outdoor Temperature (°C, DB)	Indoor Temperature (°C, WB)													
		14		16		18		19		20		22		24	
		TC	PI	TC	PI	TC	PI	TC	PI	TC	PI	TC	PI	TC	PI
80	10	13.20	1.14	15.60	1.45	17.90	1.79	18.70	1.91	19.70	1.96	21.90	2.42	24.60	2.67
	12	13.20	1.15	15.60	1.45	17.90	1.80	18.70	1.93	19.70	1.97	21.90	2.43	24.60	2.69
	14	13.20	1.16	15.60	1.46	17.90	1.81	18.70	1.94	19.70	1.99	21.90	2.45	24.60	2.71
	16	13.20	1.18	15.60	1.49	17.90	1.84	18.70	1.97	19.70	2.02	21.90	2.49	24.60	2.76
	18	13.20	1.22	15.60	1.54	17.90	1.90	18.70	2.04	19.70	2.09	21.90	2.57	24.60	2.84
	20	13.20	1.27	15.60	1.61	17.90	1.99	18.70	2.13	19.70	2.18	21.90	2.69	24.60	2.97
	21	13.20	1.30	15.60	1.64	17.90	2.03	18.70	2.18	19.70	2.23	21.90	2.75	24.60	3.04
	23	13.20	1.38	15.60	1.75	17.90	2.16	18.70	2.31	19.70	2.37	21.90	2.92	24.60	3.23
	25	13.20	1.48	15.60	1.87	17.90	2.31	18.70	2.47	19.70	2.53	21.90	3.12	24.30	3.45
	27	13.20	1.58	15.60	2.00	17.90	2.48	18.70	2.65	19.70	2.72	21.90	3.35	23.70	3.70
	29	13.20	1.72	15.60	2.17	17.90	2.68	18.70	2.88	19.70	2.95	21.80	3.63	23.40	4.02
	31	13.20	1.86	15.60	2.35	17.90	2.90	18.70	3.11	19.70	3.18	21.50	3.93	23.10	4.34
	33	13.20	1.99	15.60	2.52	17.90	3.11	18.70	3.34	19.70	3.42	21.20	4.21	22.80	4.66
	35	13.20	2.12	15.60	2.68	17.90	3.32	18.70	3.55	19.70	3.64	20.90	4.49	22.50	4.96
	37	13.00	2.19	15.30	2.77	17.50	3.43	18.40	3.67	19.40	3.83	20.50	4.66	22.10	5.16
	39	12.70	2.22	14.90	2.82	17.10	3.48	18.00	3.73	18.90	3.89	20.10	4.73	21.60	5.24
42	12.10	2.17	14.30	2.75	16.40	3.39	17.20	3.64	18.10	3.80	19.20	4.61	20.60	5.11	
44	11.60	2.04	13.70	2.58	15.70	3.19	16.40	3.42	17.30	3.57	18.40	4.34	19.70	4.81	
70	10	11.50	0.91	13.50	1.16	15.50	1.43	16.30	1.53	17.30	1.55	19.40	1.83	21.70	2.07
	12	11.50	0.92	13.50	1.16	15.50	1.44	16.30	1.54	17.30	1.56	19.40	1.84	21.70	2.08
	14	11.50	0.93	13.50	1.17	15.50	1.45	16.30	1.55	17.30	1.57	19.40	1.85	21.70	2.09
	16	11.50	0.94	13.50	1.19	15.50	1.48	16.30	1.58	17.30	1.60	19.40	1.89	21.70	2.13
	18	11.50	0.97	13.50	1.23	15.50	1.52	16.30	1.63	17.30	1.66	19.40	1.95	21.70	2.20
	20	11.50	1.01	13.50	1.28	15.50	1.58	16.30	1.69	17.30	1.72	19.40	2.02	21.70	2.28
	21	11.50	1.03	13.50	1.31	15.50	1.61	16.30	1.73	17.30	1.75	19.40	2.06	21.70	2.33
	23	11.50	1.09	13.50	1.37	15.50	1.70	16.30	1.82	17.30	1.85	19.40	2.17	21.70	2.46
	25	11.50	1.14	13.50	1.44	15.50	1.78	16.30	1.91	17.30	1.94	19.40	2.28	21.70	2.58
	27	11.50	1.21	13.50	1.53	15.50	1.89	16.30	2.03	17.30	2.06	19.40	2.42	21.50	2.74
	29	11.50	1.31	13.50	1.66	15.50	2.05	16.30	2.20	17.30	2.23	19.40	2.63	21.30	2.97
	31	11.50	1.42	13.50	1.80	15.50	2.22	16.30	2.38	17.30	2.41	19.40	2.84	21.00	3.21
	33	11.50	1.52	13.50	1.93	15.50	2.38	16.30	2.55	17.30	2.59	19.30	3.05	20.70	3.45
	35	11.50	1.62	13.50	2.05	15.50	2.54	16.30	2.72	17.30	2.76	19.00	3.24	20.40	3.67
	37	11.30	1.68	13.30	2.12	15.20	2.62	16.00	2.81	17.00	2.90	18.70	3.41	20.10	3.86
	39	11.00	1.70	13.00	2.15	14.90	2.66	15.60	2.85	16.60	2.98	18.30	3.54	19.60	4.01
42	10.50	1.66	12.40	2.10	14.20	2.59	14.90	2.78	15.80	2.91	17.50	3.59	18.70	4.06	
44	10.10	1.56	11.90	1.98	13.60	2.44	14.30	2.62	15.20	2.73	16.70	3.38	17.90	3.82	
60	10	9.70	0.73	11.40	0.92	13.10	1.13	13.80	1.22	14.90	1.21	16.60	1.45	18.40	1.61
	12	9.70	0.72	11.40	0.92	13.10	1.13	13.80	1.21	14.90	1.21	16.60	1.44	18.40	1.61
	14	9.70	0.73	11.40	0.92	13.10	1.14	13.80	1.22	14.90	1.22	16.60	1.45	18.20	1.64
	16	9.70	0.74	11.40	0.94	13.10	1.16	13.80	1.24	14.90	1.24	16.60	1.48	18.40	1.65
	18	9.70	0.77	11.40	0.97	13.10	1.20	13.80	1.29	14.90	1.28	16.60	1.53	18.40	1.71
	20	9.70	0.80	11.40	1.02	13.10	1.26	13.80	1.35	14.90	1.34	16.60	1.60	18.40	1.79
	21	9.70	0.82	11.40	1.04	13.10	1.28	13.80	1.38	14.90	1.37	16.60	1.64	18.40	1.83
	23	9.70	0.84	11.40	1.07	13.10	1.32	13.80	1.41	14.90	1.40	16.60	1.68	18.40	1.87
	25	9.70	0.88	11.40	1.12	13.10	1.38	13.80	1.48	14.90	1.47	16.60	1.76	18.40	1.97
	27	9.70	0.91	11.40	1.16	13.10	1.43	13.80	1.53	14.90	1.52	16.60	1.82	18.40	2.03
	29	9.70	0.99	11.40	1.25	13.10	1.55	13.80	1.66	14.90	1.65	16.60	1.97	18.40	2.20
	31	9.70	1.07	11.40	1.35	13.10	1.67	13.80	1.79	14.90	1.78	16.60	2.13	18.20	2.38
	33	9.70	1.15	11.40	1.45	13.10	1.80	13.80	1.92	14.90	1.91	16.60	2.29	18.00	2.55
	35	9.70	1.22	11.40	1.55	13.10	1.91	13.80	2.05	14.90	2.04	16.60	2.44	17.70	2.72
	37	9.60	1.26	11.20	1.60	12.90	1.98	13.50	2.12	14.60	2.14	16.30	2.56	17.40	2.86
	39	9.40	1.28	11.00	1.62	12.60	2.00	13.20	2.15	14.30	2.23	15.90	2.66	17.00	2.97
42	8.90	1.25	10.50	1.58	12.00	1.96	12.60	2.10	13.70	2.19	15.20	2.72	16.30	3.03	
44	8.60	1.18	10.00	1.49	11.50	1.84	12.10	1.97	13.10	2.06	14.50	2.65	15.60	2.98	
50	10	8.30	0.52	9.70	0.66	11.10	0.82	11.70	0.88	12.70	0.87	14.30	1.07	15.40	1.19
	12	8.30	0.52	9.70	0.66	11.10	0.82	11.70	0.88	12.70	0.87	14.30	1.06	15.40	1.19
	14	8.30	0.53	9.70	0.67	11.10	0.82	11.70	0.88	12.70	0.88	14.30	1.07	15.40	1.20
	16	8.30	0.54	9.70	0.68	11.10	0.84	11.70	0.90	12.70	0.89	14.30	1.09	15.40	1.22
	18	8.30	0.55	9.70	0.70	11.10	0.87	11.70	0.93	12.70	0.92	14.30	1.13	15.40	1.26
	20	8.30	0.58	9.70	0.73	11.10	0.91	11.70	0.97	12.70	0.97	14.30	1.18	15.40	1.32
	21	8.30	0.59	9.70	0.75	11.10	0.93	11.70	0.99	12.70	0.99	14.30	1.21	15.40	1.35
	23	8.30	0.60	9.70	0.76	11.10	0.94	11.70	1.01	12.70	1.00	14.30	1.23	15.40	1.37
	25	8.30	0.63	9.70	0.80	11.10	0.99	11.70	1.06	12.70	1.06	14.30	1.29	15.40	1.44
	27	8.30	0.65	9.70	0.83	11.10	1.02	11.70	1.09	12.70	1.09	14.30	1.33	15.40	1.49
	29	8.30	0.71	9.70	0.90	11.10	1.11	11.70	1.19	12.70	1.18	14.30	1.44	15.40	1.61
	31	8.30	0.77	9.70	0.97	11.10	1.20	11.70	1.28	12.70	1.28	14.30	1.56	15.40	1.74
	33	8.30	0.82	9.70	1.04	11.10	1.28	11.70	1.38	12.70	1.37	14.30	1.67	15.40	1.87
	35	8.30	0.87	9.70	1.11	11.10	1.37	11.70	1.47	12.70	1.46	14.30	1.78	15.30	1.99
	37	8.10	0.90	9.50	1.14	10.90	1.41	11.50	1.51	12.40	1.53	14.00	1.87	15.00	2.10
	39	7.90	0.92	9.30	1.16	10.70	1.43	11.20	1.54	12.20	1.59	13.70	1.95	14.70	2.18
42	7.60	0.90	8.90	1.13	10.20	1.40	10.70	1.50	11.60	1.57	13.10	1.99	14.00	2.22	
44	7.30	0.84	8.50	1.07	9.80	1.32	10.30	1.41	11.10	1.47	12.60	1.95	13.40	2.19	

Capacity table

AM080FXMDGH/EU

Heating

TC : Total Capacity, PI : Power Input

Combination, % (Capacity index)	Outdoor Temperature (°C)		Indoor Temperature (°C, DB)									
			16		18		20		22		24	
			TC	PI	TC	PI	TC	PI	TC	PI	TC	PI
	DB	WB	kW	kW	kW	kW	kW	kW	kW	kW	kW	kW
130	-20	-21	17.80	5.06	17.50	5.11	17.00	5.16	16.80	5.25	16.60	5.35
	-17	-18	19.30	5.14	19.10	5.19	18.50	5.24	18.30	5.34	18.00	5.44
	-15	-16	20.90	5.21	20.60	5.26	20.00	5.31	19.80	5.41	19.50	5.51
	-12	-13	22.40	5.24	22.10	5.29	21.40	5.34	21.20	5.45	20.90	5.55
	-10	-11	23.50	5.28	23.10	5.33	22.40	5.38	22.10	5.49	21.90	5.59
	-7	-8	25.10	5.29	24.70	5.35	24.00	5.40	23.70	5.50	23.40	5.61
	-5	-6	26.40	4.80	26.00	4.85	25.30	4.89	25.00	4.99	24.60	5.08
	-3	-4	27.20	4.85	26.80	4.89	26.00	4.94	25.70	5.04	25.40	5.13
	0	-1	28.10	4.40	27.60	4.44	26.80	4.48	26.50	4.57	26.20	4.66
	3	2	28.90	4.49	28.50	4.53	27.60	4.57	27.30	4.66	26.90	4.75
	5	4	30.20	4.58	29.70	4.62	28.80	4.67	28.50	4.76	28.10	4.85
	7	6	30.80	4.67	30.40	4.71	29.50	4.75	29.10	4.85	28.70	4.94
	9	8	31.70	4.71	31.20	4.75	30.30	4.80	29.90	4.89	29.50	4.98
	11	10	32.60	4.75	32.10	4.80	31.10	4.85	30.80	4.94	30.40	5.03
	13	12	33.50	4.80	33.00	4.84	31.80	4.86	31.40	4.95	31.00	5.04
15	14	34.40	4.89	33.80	4.93	31.80	4.82	31.40	4.92	31.00	5.01	
120	-20	-21	17.70	5.19	17.00	5.24	16.70	5.29	16.50	5.39	16.30	5.49
	-17	-18	19.20	5.27	18.50	5.32	18.10	5.37	17.90	5.48	17.70	5.58
	-15	-16	20.80	5.34	20.00	5.39	19.60	5.44	19.40	5.55	19.20	5.65
	-12	-13	22.30	5.38	21.50	5.43	21.00	5.48	20.80	5.59	20.50	5.69
	-10	-11	23.30	5.41	22.40	5.47	22.00	5.52	21.70	5.63	21.50	5.73
	-7	-8	24.90	5.43	24.00	5.48	23.60	5.54	23.30	5.64	23.00	5.75
	-5	-6	26.20	4.92	25.30	4.97	24.80	5.02	24.50	5.12	24.20	5.21
	-3	-4	27.00	4.97	26.10	5.02	25.60	5.07	25.20	5.17	24.90	5.26
	0	-1	27.80	4.51	26.90	4.55	26.30	4.60	26.00	4.69	25.70	4.78
	3	2	28.70	4.60	27.70	4.65	27.10	4.69	26.80	4.78	26.40	4.87
	5	4	29.90	4.69	28.90	4.74	28.30	4.79	28.00	4.88	27.60	4.97
	7	6	30.60	4.79	29.50	4.83	28.90	4.88	28.60	4.97	28.20	5.07
	9	8	31.10	4.82	30.60	4.86	30.30	4.91	30.00	5.00	29.60	5.10
	11	10	32.00	4.88	30.90	4.93	30.40	4.85	30.00	4.95	29.70	5.04
	13	12	32.90	4.98	31.70	5.03	30.40	4.83	30.00	4.92	29.70	5.01
15	14	33.10	4.96	31.90	5.00	30.40	4.77	30.00	4.86	29.70	4.95	
110	-20	-21	17.50	5.31	16.70	5.36	15.90	5.42	15.70	5.52	15.50	5.62
	-17	-18	19.10	5.40	18.20	5.45	17.30	5.50	17.10	5.61	16.90	5.71
	-15	-16	20.60	5.47	19.70	5.52	18.70	5.58	18.50	5.68	18.20	5.79
	-12	-13	22.10	5.50	21.10	5.56	20.10	5.61	19.80	5.72	19.60	5.83
	-10	-11	23.10	5.54	22.10	5.60	21.00	5.65	20.70	5.76	20.40	5.87
	-7	-8	24.70	5.56	23.60	5.62	22.40	5.67	22.20	5.78	21.90	5.89
	-5	-6	26.10	5.04	24.90	5.09	23.60	5.14	23.30	5.24	23.00	5.34
	-3	-4	26.90	5.09	25.60	5.14	24.40	5.19	24.00	5.29	23.70	5.39
	0	-1	27.40	4.62	26.40	4.66	25.10	4.71	24.80	4.80	24.50	4.89
	3	2	27.90	4.71	27.20	4.76	25.80	4.81	25.50	4.90	25.20	4.99
	5	4	29.10	4.81	28.40	4.85	27.00	4.90	26.60	5.00	26.30	5.09
	7	6	29.80	4.90	29.00	4.95	27.30	4.95	26.90	5.04	26.60	5.14
	9	8	30.30	4.98	29.00	4.80	27.30	4.80	26.90	4.89	26.60	4.98
	11	10	30.70	4.92	29.00	4.68	27.30	4.68	26.90	4.77	26.60	4.86
	13	12	30.70	4.82	29.00	4.55	27.30	4.55	26.90	4.64	26.60	4.73
15	14	30.70	4.77	29.00	4.43	27.30	4.43	26.90	4.51	26.60	4.60	
100	-20	-21	17.20	5.51	16.30	5.56	15.30	5.62	15.10	5.72	14.90	5.83
	-17	-18	18.70	5.59	17.70	5.65	16.70	5.70	16.40	5.81	16.20	5.92
	-15	-16	20.30	5.67	19.10	5.73	18.00	5.78	17.80	5.89	17.60	6.00
	-12	-13	21.70	5.71	20.50	5.76	19.30	5.82	19.10	5.93	18.80	6.04
	-10	-11	22.70	5.75	21.50	5.81	20.20	5.86	19.90	5.97	19.70	6.09
	-7	-8	24.30	5.77	23.00	5.82	21.60	5.88	21.30	5.99	21.10	6.11
	-5	-6	25.60	5.23	24.20	5.28	22.80	5.33	22.50	5.43	22.20	5.54
	-3	-4	26.40	5.28	24.90	5.33	23.50	5.38	23.20	5.48	22.90	5.59
	0	-1	27.20	4.79	25.70	4.84	24.20	4.88	23.90	4.98	23.60	5.07
	3	2	28.00	4.89	26.40	4.93	24.90	4.98	24.60	5.08	24.30	5.17
	5	4	28.10	4.80	26.60	4.84	25.00	4.89	24.70	4.98	24.40	5.08
	7	6	28.10	4.79	26.60	4.83	25.00	4.88	24.70	4.97	24.40	5.07
	9	8	28.10	4.70	26.60	4.75	25.00	4.79	24.70	4.89	24.40	4.98
	11	10	28.10	4.67	26.60	4.58	25.00	4.62	24.70	4.71	24.40	4.80
	13	12	28.10	4.50	26.60	4.41	25.00	4.45	24.70	4.54	24.40	4.62
15	14	28.10	4.46	26.60	4.25	25.00	4.29	24.70	4.37	24.40	4.46	
90	-20	-21	16.20	5.45	15.70	5.51	15.10	5.56	14.90	5.67	14.70	5.77
	-17	-18	17.60	5.54	17.10	5.59	16.40	5.65	16.20	5.76	16.00	5.87
	-15	-16	19.10	5.61	18.50	5.67	17.80	5.72	17.50	5.83	17.30	5.95
	-12	-13	20.40	5.65	19.80	5.71	19.00	5.76	18.80	5.87	18.50	5.98
	-10	-11	21.60	5.69	20.90	5.75	20.10	5.80	19.80	5.92	19.60	6.03
	-7	-8	22.90	5.71	22.20	5.77	21.30	5.82	21.00	5.93	20.80	6.05
	-5	-6	24.10	5.18	23.30	5.23	22.40	5.28	22.10	5.38	21.90	5.48
	-3	-4	24.80	5.23	24.10	5.28	22.70	5.23	22.40	5.33	22.10	5.44
	0	-1	25.50	4.73	24.10	4.66	22.70	4.61	22.40	4.70	22.10	4.79
	3	2	25.50	4.69	24.10	4.62	22.70	4.57	22.40	4.66	22.10	4.74
	5	4	25.50	4.58	24.10	4.51	22.70	4.46	22.40	4.55	22.10	4.63
	7	6	25.50	4.57	24.10	4.50	22.70	4.45	22.40	4.54	22.10	4.62
	9	8	25.50	4.49	24.10	4.42	22.70	4.37	22.40	4.46	22.10	4.54
	11	10	25.50	4.33	24.10	4.26	22.70	4.22	22.40	4.30	22.10	4.38
	13	12	25.50	4.17	24.10	4.11	22.70	4.06	22.40	4.14	22.10	4.22
15	14	25.50	4.02	24.10	3.96	22.70	3.92	22.40	3.99	22.10	4.07	
80	-20	-21	16.00	5.39	15.60	5.44	15.00	5.49	14.80	5.60	14.60	5.70
	-17	-18	17.40	5.47	16.90	5.53	16.30	5.58	16.10	5.69	15.90	5.79
	-15	-16	18.80	5.55	18.30	5.60	17.60	5.66	17.40	5.76	17.20	5.87
	-12	-13	20.10	5.58	19.60	5.64	18.90	5.69	18.60	5.80	18.40	5.91
	-10	-11	21.30	5.62	20.70	5.68	19.90	5.73	19.70	5.84	19.40	5.95
	-7	-8	22.60	5.64	21.40	5.65	20.10	5.69	19.90	5.79	19.60	5.70
	-5	-6	22.70	4.88	21.40	4.78	20.10	4.73	19.90	4.82	19.60	4.91
	-3	-4	22.70	4.78	21.40	4.68	20.10	4.63	19.90	4.72	19.60	4.81
	0	-1	22.70	4.21	21.40	4.12	20.10	4.08	19.90	4.16	19.60	4.24
3	2	22.70	4.17	21.40	4.09	20.10	4.04	19.90	4.12	19.60	4.20	

Capacity table

AM080FXMDGH/EU

Heating

TC : Total Capacity, PI : Power Input

Combination, % (Capacity index)	Outdoor Temperature (°C)		Indoor Temperature (°C, DB)									
			16		18		20		22		24	
			TC	PI	TC	PI	TC	PI	TC	PI	TC	PI
	DB	WB	kW		kW		kW		kW		kW	
80	5	4	22.70	4.08	21.40	3.99	20.10	3.95	19.90	4.02	19.60	4.10
	7	6	22.70	4.07	21.40	3.98	20.10	3.94	19.90	4.02	19.60	4.09
	9	8	22.70	4.00	21.40	3.91	20.10	3.87	19.90	3.94	19.60	4.02
	11	10	22.70	3.85	21.40	3.77	20.10	3.73	19.90	3.80	19.60	3.87
	13	12	22.70	3.71	21.40	3.63	20.10	3.60	19.90	3.66	19.60	3.73
	15	14	22.70	3.58	21.40	3.50	20.10	3.46	19.90	3.53	19.60	3.60
70	-20	-21	16.00	5.20	15.30	5.25	14.70	5.30	14.50	5.40	14.30	5.50
	-17	-18	17.40	5.28	16.60	5.33	16.00	5.38	15.80	5.49	15.60	5.59
	-15	-16	18.90	5.35	18.00	5.40	17.30	5.45	17.10	5.56	16.80	5.66
	-12	-13	19.80	5.28	18.70	5.28	17.60	5.23	17.40	5.33	17.20	5.43
	-10	-11	19.80	4.98	18.70	4.98	17.60	4.93	17.40	5.02	17.20	5.12
	-7	-8	19.80	4.77	18.70	4.77	17.60	4.72	17.40	4.81	17.20	4.90
	-5	-6	19.80	4.11	18.70	4.11	17.60	4.06	17.40	4.14	17.20	4.22
	-3	-4	19.80	4.02	18.70	4.02	17.60	3.98	17.40	4.06	17.20	4.13
	0	-1	19.80	3.54	18.70	3.54	17.60	3.51	17.40	3.57	17.20	3.64
	3	2	19.80	3.51	18.70	3.51	17.60	3.47	17.40	3.54	17.20	3.61
	5	4	19.80	3.43	18.70	3.43	17.60	3.39	17.40	3.46	17.20	3.52
	7	6	19.80	3.42	18.70	3.42	17.60	3.39	17.40	3.45	17.20	3.52
	9	8	19.80	3.36	18.70	3.36	17.60	3.33	17.40	3.39	17.20	3.45
	11	10	19.80	3.24	18.70	3.24	17.60	3.21	17.40	3.27	17.20	3.33
13	12	19.80	3.12	18.70	3.12	17.60	3.09	17.40	3.15	17.20	3.21	
15	14	19.80	3.01	18.70	3.01	17.60	2.98	17.40	3.03	17.20	3.09	
60	-20	-21	15.30	4.87	14.50	4.92	13.60	4.97	13.50	5.06	13.30	5.16
	-17	-18	16.70	4.95	15.70	5.00	14.80	5.04	14.60	5.14	14.50	5.24
	-15	-16	17.00	4.72	16.10	4.77	15.10	4.82	14.90	4.91	14.70	5.00
	-12	-13	17.00	4.44	16.10	4.48	15.10	4.53	14.90	4.61	14.70	4.70
	-10	-11	17.00	4.19	16.10	4.23	15.10	4.27	14.90	4.35	14.70	4.43
	-7	-8	17.00	4.01	16.10	4.04	15.10	4.08	14.90	4.16	14.70	4.24
	-5	-6	17.00	3.45	16.10	3.48	15.10	3.52	14.90	3.59	14.70	3.65
	-3	-4	17.00	3.38	16.10	3.41	15.10	3.45	14.90	3.51	14.70	3.58
	0	-1	17.00	2.98	16.10	3.01	15.10	3.03	14.90	3.09	14.70	3.15
	3	2	17.00	2.95	16.10	2.98	15.10	3.01	14.90	3.07	14.70	3.12
	5	4	17.00	2.88	16.10	2.91	15.10	2.94	14.90	2.99	14.70	3.05
	7	6	17.00	2.87	16.10	2.90	15.10	2.93	14.90	2.99	14.70	3.04
	9	8	17.00	2.82	16.10	2.85	15.10	2.88	14.90	2.93	14.70	2.99
	11	10	17.00	2.72	16.10	2.75	15.10	2.78	14.90	2.83	14.70	2.88
13	12	17.00	2.62	16.10	2.65	15.10	2.67	14.90	2.73	14.70	2.78	
15	14	17.00	2.53	16.10	2.55	15.10	2.58	14.90	2.63	14.70	2.68	
50	-20	-21	13.80	4.32	13.00	4.36	12.30	4.40	12.10	4.49	12.00	4.57
	-17	-18	14.10	4.11	13.30	4.15	12.50	4.19	12.30	4.27	12.20	4.35
	-15	-16	14.10	3.85	13.30	3.88	12.50	3.92	12.30	4.00	12.20	4.07
	-12	-13	14.10	3.61	13.30	3.65	12.50	3.69	12.30	3.76	12.20	3.83
	-10	-11	14.10	3.41	13.30	3.44	12.50	3.48	12.30	3.54	12.20	3.61
	-7	-8	14.10	3.26	13.30	3.29	12.50	3.33	12.30	3.39	12.20	3.45
	-5	-6	14.10	2.81	13.30	2.84	12.50	2.86	12.30	2.92	12.20	2.98
	-3	-4	14.10	2.75	13.30	2.78	12.50	2.81	12.30	2.86	12.20	2.91
	0	-1	14.10	2.42	13.30	2.45	12.50	2.47	12.30	2.52	12.20	2.57
	3	2	14.10	2.40	13.30	2.43	12.50	2.45	12.30	2.50	12.20	2.54
	5	4	14.10	2.35	13.30	2.37	12.50	2.39	12.30	2.44	12.20	2.48
	7	6	14.10	2.34	13.30	2.36	12.50	2.39	12.30	2.43	12.20	2.48
	9	8	14.10	2.30	13.30	2.32	12.50	2.34	12.30	2.39	12.20	2.44
	11	10	14.10	2.22	13.30	2.24	12.50	2.26	12.30	2.30	12.20	2.35
13	12	14.10	2.14	13.30	2.16	12.50	2.18	12.30	2.22	12.20	2.26	
15	14	14.10	2.06	13.30	2.08	12.50	2.10	12.30	2.14	12.20	2.18	

Capacity table

AM090FXMDGH/EU

Cooling

TC : Total Capacity, PI : Power Input

Combination, % (Capacity index)	Outdoor Temperature (°C, DB)	Indoor Temperature (°C, WB)														
		14		16		18		19		20		22		24		
		TC kW	PI kW	TC kW	PI kW	TC kW	PI kW	TC kW	PI kW	TC kW	PI kW	TC kW	PI kW	TC kW	PI kW	
130	10	20.80	3.05	25.90	3.94	28.80	4.30	30.60	4.77	30.40	4.99	31.60	5.14	32.80	5.16	
	12	20.80	3.07	25.90	3.96	28.80	4.33	30.40	4.77	30.10	4.98	31.40	5.13	32.50	5.15	
	14	20.80	3.12	25.90	4.03	28.80	4.40	30.10	4.79	29.80	5.01	31.10	5.15	32.20	5.18	
	16	20.80	3.21	25.90	4.14	28.60	4.52	29.70	4.87	29.40	5.08	30.70	5.23	31.80	5.26	
	18	20.80	3.34	25.90	4.31	28.30	4.67	29.30	5.00	29.10	5.23	30.30	5.38	31.40	5.41	
	20	20.80	3.53	25.90	4.55	27.90	4.86	28.90	5.21	28.70	5.44	29.90	5.60	31.00	5.63	
	21	20.80	3.64	25.90	4.69	27.70	4.98	28.70	5.34	28.50	5.58	29.70	5.74	30.70	5.77	
	23	20.80	3.90	25.90	5.04	27.30	5.27	28.30	5.65	28.10	5.91	29.30	6.08	30.30	6.11	
	25	20.80	4.22	25.60	5.44	27.00	5.62	28.00	6.03	27.70	6.30	28.90	6.48	30.00	6.52	
	27	20.80	4.57	25.30	5.90	26.60	6.02	27.60	6.45	27.40	6.74	28.50	6.94	29.60	6.97	
	29	20.80	4.95	25.00	6.39	26.30	6.45	27.30	6.91	27.10	7.22	28.20	7.43	29.20	7.47	
	31	20.80	5.35	24.70	6.91	26.00	6.88	27.00	7.37	26.70	7.70	27.80	7.93	28.90	7.97	
	33	20.70	5.75	24.30	7.42	25.60	7.29	26.60	7.81	26.40	8.16	27.50	8.40	28.50	8.44	
	35	20.40	6.12	24.00	7.89	25.20	7.64	26.20	8.19	26.00	8.55	27.10	8.80	28.00	8.85	
	37	20.00	6.44	23.50	8.31	24.80	7.90	25.70	8.46	25.50	8.84	26.60	9.10	27.50	9.15	
	39	19.60	6.68	23.00	8.43	24.20	8.02	25.20	8.59	24.90	8.98	26.00	9.24	26.90	9.29	
	42	18.70	6.75	22.00	8.23	23.10	7.82	24.00	8.38	23.80	8.76	24.80	9.01	25.70	9.06	
	44	17.90	6.35	21.00	7.74	22.20	7.36	23.00	7.88	22.80	8.24	23.80	8.48	24.60	8.52	
	120	10	19.40	2.71	23.40	3.40	27.00	3.72	28.90	4.32	29.90	4.71	31.20	4.85	32.00	4.87
		12	19.40	2.73	23.40	3.42	27.00	3.74	28.90	4.35	29.70	4.70	30.90	4.84	31.70	4.87
14		19.40	2.80	23.40	3.51	27.00	3.84	28.90	4.46	29.40	4.78	30.60	4.92	31.40	4.94	
16		19.40	2.88	23.40	3.61	27.00	3.95	28.90	4.58	29.00	4.85	30.20	4.99	31.00	5.02	
18		19.40	3.00	23.40	3.76	27.00	4.11	28.90	4.77	28.60	4.99	29.80	5.13	30.60	5.16	
20		19.40	3.17	23.40	3.97	27.00	4.34	28.50	4.97	28.20	5.19	29.40	5.34	30.20	5.37	
21		19.40	3.27	23.40	4.09	27.00	4.48	28.30	5.09	28.00	5.32	29.20	5.48	30.00	5.50	
23		19.40	3.51	23.40	4.39	27.00	4.80	27.90	5.39	27.70	5.63	28.80	5.80	29.60	5.83	
25		19.40	3.79	23.40	4.74	27.00	5.19	27.60	5.75	27.30	6.01	28.50	6.18	29.20	6.21	
27		19.40	4.11	23.40	5.14	26.80	5.62	27.20	6.15	27.00	6.43	28.10	6.62	28.80	6.65	
29		19.40	4.45	23.40	5.57	26.40	6.10	26.90	6.59	26.70	6.88	27.80	7.09	28.50	7.12	
31		19.40	4.81	23.40	6.02	26.10	6.56	26.60	7.03	26.30	7.35	27.40	7.56	28.10	7.60	
33		19.40	5.16	23.40	6.46	25.80	6.95	26.20	7.45	26.00	7.78	27.10	8.01	27.80	8.05	
35		19.40	5.50	23.20	6.88	25.40	7.29	25.80	7.81	25.60	8.16	26.70	8.40	27.30	8.44	
37		19.00	5.79	22.80	7.24	24.90	7.53	25.30	8.07	25.10	8.43	26.20	8.68	26.90	8.73	
39		18.60	6.01	22.30	7.52	24.40	7.65	24.80	8.19	24.60	8.56	25.60	8.81	26.30	8.86	
42		17.80	5.96	21.30	7.55	23.30	7.46	23.70	7.99	23.40	8.35	24.40	8.59	25.10	8.64	
44		17.00	5.61	20.40	7.10	22.30	7.02	22.70	7.52	22.50	7.86	23.40	8.09	24.00	8.13	
110		10	17.80	2.36	22.00	2.97	24.80	3.25	26.50	3.77	28.10	4.22	30.40	4.51	31.20	4.54
		12	17.80	2.37	22.00	2.99	24.80	3.27	26.50	3.79	28.10	4.25	30.40	4.51	31.00	4.53
	14	17.80	2.43	22.00	3.07	24.80	3.36	26.50	3.89	28.10	4.36	30.20	4.58	30.60	4.60	
	16	17.80	2.50	22.00	3.15	24.80	3.45	26.50	4.00	28.10	4.48	29.80	4.65	30.30	4.67	
	18	17.80	2.61	22.00	3.28	24.80	3.60	26.50	4.17	28.10	4.64	29.40	4.78	29.90	4.80	
	20	17.80	2.75	22.00	3.47	24.80	3.80	26.50	4.40	28.10	4.83	29.00	4.97	29.50	5.00	
	21	17.80	2.84	22.00	3.58	24.80	3.92	26.50	4.54	28.00	4.95	28.80	5.10	29.30	5.13	
	23	17.80	3.05	22.00	3.84	24.80	4.20	26.50	4.87	27.60	5.24	28.50	5.40	28.90	5.43	
	25	17.80	3.29	22.00	4.15	24.80	4.54	26.50	5.26	27.20	5.59	28.10	5.76	28.50	5.79	
	27	17.80	3.57	22.00	4.49	24.80	4.92	26.50	5.70	26.90	5.99	27.70	6.16	28.20	6.19	
	29	17.80	3.87	22.00	4.87	24.80	5.33	26.30	6.13	26.60	6.41	27.40	6.60	27.80	6.63	
	31	17.80	4.18	22.00	5.26	24.80	5.76	25.90	6.54	26.20	6.84	27.10	7.04	27.50	7.08	
	33	17.80	4.48	22.00	5.65	24.80	6.19	25.60	6.93	25.90	7.25	26.70	7.46	27.10	7.50	
	35	17.80	4.77	22.00	6.01	24.80	6.59	25.20	7.27	25.50	7.60	26.30	7.82	26.70	7.86	
	37	17.50	4.93	21.60	6.33	24.30	6.93	24.70	7.52	25.00	7.85	25.80	8.08	26.20	8.12	
	39	17.10	5.01	21.10	6.57	23.80	7.12	24.20	7.63	24.50	7.97	25.30	8.20	25.60	8.25	
	42	16.40	4.89	20.20	6.46	22.70	6.94	23.10	7.44	23.40	7.78	24.10	8.00	24.50	8.04	
	44	15.70	4.60	19.30	6.08	21.70	6.53	22.10	7.00	22.40	7.32	23.10	7.53	23.40	7.57	
	100	10	17.10	2.05	20.00	2.60	23.00	3.21	24.10	3.44	26.10	3.78	28.20	4.07	30.30	4.28
		12	17.10	2.07	20.00	2.62	23.00	3.23	24.10	3.46	26.10	3.80	28.20	4.10	30.30	4.31
14		17.10	2.10	20.00	2.66	23.00	3.28	24.10	3.52	26.10	3.86	28.20	4.16	30.20	4.37	
16		17.10	2.16	20.00	2.73	23.00	3.38	24.10	3.62	26.10	3.97	28.20	4.28	29.80	4.43	
18		17.10	2.25	20.00	2.85	23.00	3.52	24.10	3.77	26.10	4.13	28.20	4.46	29.50	4.56	
20		17.10	2.37	20.00	3.00	23.00	3.71	24.10	3.98	26.10	4.36	28.20	4.70	29.10	4.75	
21		17.10	2.45	20.00	3.10	23.00	3.83	24.10	4.10	26.10	4.50	28.10	4.84	28.90	4.86	
23		17.10	2.63	20.00	3.33	23.00	4.11	24.10	4.40	26.10	4.83	27.80	5.12	28.50	5.15	
25		17.10	2.84	20.00	3.59	23.00	4.44	24.10	4.76	26.10	5.22	27.40	5.46	28.10	5.49	
27		17.10	3.08	20.00	3.89	23.00	4.81	24.10	5.15	26.10	5.66	27.10	5.85	27.80	5.88	
29		17.10	3.34	20.00	4.22	23.00	5.21	24.10	5.59	25.90	6.08	26.70	6.26	27.40	6.29	
31		17.10	3.60	20.00	4.56	23.00	5.63	24.10	6.04	25.60	6.49	26.40	6.68	27.10	6.72	
33		17.10	3.87	20.00	4.90	23.00	6.05	24.10	6.48	25.30	6.88	26.10	7.08	26.70	7.12	
35		17.10	4.12	20.00	5.21	23.00	6.44	24.10	6.90	24.90	7.21	25.70	7.42	26.30	7.46	
37		16.80	4.26	19.70	5.39	22.60	6.66	23.70	7.13	24.40	7.45	25.20	7.67	25.90	7.71	
39		16.40	4.32	19.20	5.47	22.10	6.76	23.10	7.24	23.90	7.56	24.60	7.79	25.30	7.83	
42		15.60	4.22	18.40	5.33	21.10	6.59	22.10	7.06	22.80	7.38	23.50	7.59	24.10	7.64	
44		15.00	3.97	17.60	5.02	20.20	6.20	21.20	6.64	21.80	6.94	22.50	7.15	23.10	7.18	
90		10	15.90	1.64	18.60	2.08	21.40	2.57	22.40	2.75	23.70	2.94	25.60	3.43	28.00	3.59
		12	15.90	1.65	18.60	2.09	21.40	2.58	22.40	2.77	23.70	2.96	25.60	3.45	28.00	3.62
	14	15.90	1.68	18.60	2.12	21.40	2.62	22.40	2.81	23.70	3.01	25.60	3.50	28.00	3.68	
	16	15.90	1.72	18.60	2.18	21.40	2.70	22.40	2.89	23.70	3.09	25.60	3.60	28.00	3.78	
	18	15.90	1.80	18.60	2.27	21.40	2.81	22.40	3.01	23.70	3.22	25.60	3.75	27.90	3.94	
	20	15.90	1.90	18.60	2.40	21.40	2.97	22.40	3.18	23.70	3.40	25.60	3.96	27.60	4.15	
	21	15.90	1.96	18.60	2.48	21.40	3.06	22.40	3.28	23.70	3.51	25.60	4.08	27.40	4.28	
	23	15.90	2.10	18.60	2.66	21.40	3.28	22.40	3.52	23.70	3.76	25.60	4.38	27.00	4.53	
	25	15.90	2.27	18.60	2.87	21.40	3.55	22.40	3.80	23.70	4.06	25.50	4.71	26.70	4.83	
	27	15.90	2.46	18.60	3.11	21.40	3.8									

Capacity table

AM090FXMDGH/EU

Cooling

TC : Total Capacity, PI : Power Input

Combination, % (Capacity index)	Outdoor Temperature (°C, DB)	Indoor Temperature (°C, WB)													
		14		16		18		19		20		22		24	
		TC kW	PI kW	TC kW	PI kW	TC kW	PI kW	TC kW	PI kW	TC kW	PI kW	TC kW	PI kW	TC kW	PI kW
80	10	14.30	1.38	16.70	1.74	19.20	2.15	20.10	2.31	21.20	2.36	23.50	2.92	26.40	3.22
	12	14.30	1.39	16.70	1.76	19.20	2.17	20.10	2.32	21.20	2.38	23.50	2.93	26.40	3.24
	14	14.30	1.40	16.70	1.77	19.20	2.18	20.10	2.34	21.20	2.40	23.50	2.95	26.40	3.26
	16	14.30	1.42	16.70	1.80	19.20	2.22	20.10	2.38	21.20	2.44	23.50	3.01	26.40	3.32
	18	14.30	1.47	16.70	1.86	19.20	2.29	20.10	2.46	21.20	2.52	23.50	3.10	26.40	3.43
	20	14.30	1.53	16.70	1.94	19.20	2.40	20.10	2.57	21.20	2.63	23.50	3.24	26.40	3.59
	21	14.30	1.57	16.70	1.98	19.20	2.45	20.10	2.63	21.20	2.69	23.50	3.32	26.40	3.66
	23	14.30	1.66	16.70	2.11	19.20	2.60	20.10	2.79	21.20	2.86	23.50	3.52	26.20	3.89
	25	14.30	1.78	16.70	2.25	19.20	2.78	20.10	2.98	21.20	3.06	23.50	3.77	25.80	4.16
	27	14.30	1.91	16.70	2.42	19.20	2.99	20.10	3.20	21.20	3.28	23.50	4.04	25.50	4.47
	29	14.30	2.07	16.70	2.62	19.20	3.24	20.10	3.47	21.20	3.55	23.50	4.38	25.20	4.84
	31	14.30	2.24	16.70	2.83	19.20	3.50	20.10	3.75	21.20	3.84	23.20	4.73	24.90	5.23
	33	14.30	2.40	16.70	3.04	19.20	3.76	20.10	4.03	21.20	4.12	22.90	5.08	24.60	5.62
	35	14.30	2.56	16.70	3.24	19.20	4.00	20.10	4.29	21.20	4.39	22.50	5.41	24.20	5.98
	37	14.00	2.64	16.40	3.35	18.90	4.13	19.80	4.43	20.80	4.62	22.10	5.62	23.80	6.23
	39	13.70	2.68	16.10	3.40	18.40	4.20	19.30	4.50	20.40	4.70	21.60	5.71	23.20	6.32
	42	13.10	2.62	15.40	3.31	17.60	4.09	18.50	4.39	19.40	4.58	20.60	5.57	22.20	6.16
44	12.50	2.46	14.70	3.12	16.90	3.85	17.70	4.13	18.60	4.31	19.80	5.24	21.20	5.80	
70	10	12.40	1.10	14.50	1.40	16.70	1.72	17.50	1.85	18.60	1.87	20.80	2.20	23.40	2.49
	12	12.40	1.11	14.50	1.40	16.70	1.74	17.50	1.86	18.60	1.89	20.80	2.22	23.40	2.51
	14	12.40	1.12	14.50	1.41	16.70	1.75	17.50	1.87	18.60	1.90	20.80	2.23	23.40	2.53
	16	12.40	1.14	14.50	1.44	16.70	1.78	17.50	1.91	18.60	1.93	20.80	2.28	23.40	2.57
	18	12.40	1.17	14.50	1.49	16.70	1.84	17.50	1.97	18.60	2.00	20.80	2.35	23.40	2.66
	20	12.40	1.22	14.50	1.54	16.70	1.90	17.50	2.04	18.60	2.07	20.80	2.43	23.40	2.75
	21	12.40	1.24	14.50	1.58	16.70	1.95	17.50	2.09	18.60	2.12	20.80	2.49	23.40	2.82
	23	12.40	1.31	14.50	1.66	16.70	2.05	17.50	2.20	18.60	2.23	20.80	2.62	23.40	2.96
	25	12.40	1.38	14.50	1.74	16.70	2.15	17.50	2.30	18.60	2.34	20.80	2.75	23.40	3.11
	27	12.40	1.46	14.50	1.85	16.70	2.28	17.50	2.45	18.60	2.48	20.80	2.92	23.20	3.31
	29	12.40	1.58	14.50	2.00	16.70	2.48	17.50	2.65	18.60	2.69	20.80	3.17	22.90	3.58
	31	12.40	1.71	14.50	2.17	16.70	2.68	17.50	2.87	18.60	2.91	20.80	3.42	22.60	3.87
	33	12.40	1.84	14.50	2.33	16.70	2.87	17.50	3.08	18.60	3.12	20.80	3.67	22.30	4.16
	35	12.40	1.96	14.50	2.48	16.70	3.06	17.50	3.28	18.60	3.32	20.50	3.91	22.00	4.42
	37	12.20	2.02	14.30	2.56	16.40	3.16	17.20	3.39	18.30	3.50	20.10	4.12	21.60	4.66
	39	11.90	2.05	14.00	2.60	16.00	3.21	16.80	3.44	17.90	3.59	19.70	4.27	21.10	4.83
	42	11.30	2.00	13.30	2.53	15.30	3.13	16.00	3.35	17.00	3.50	18.80	4.33	20.10	4.89
44	10.90	1.88	12.80	2.38	14.70	2.95	15.40	3.16	16.30	3.30	18.00	4.07	19.30	4.61	
60	10	10.50	0.88	12.30	1.11	14.10	1.37	14.80	1.47	16.00	1.46	17.80	1.74	19.70	1.95
	12	10.50	0.87	12.30	1.11	14.10	1.37	14.80	1.46	16.00	1.46	17.80	1.74	19.70	1.94
	14	10.50	0.88	12.30	1.11	14.10	1.38	14.80	1.47	16.00	1.47	17.80	1.75	19.60	1.97
	16	10.50	0.90	12.30	1.13	14.10	1.40	14.80	1.50	16.00	1.49	17.80	1.79	19.70	1.99
	18	10.50	0.93	12.30	1.17	14.10	1.45	14.80	1.55	16.00	1.54	17.80	1.84	19.70	2.06
	20	10.50	0.97	12.30	1.23	14.10	1.51	14.80	1.62	16.00	1.61	17.80	1.93	19.70	2.15
	21	10.50	0.99	12.30	1.25	14.10	1.55	14.80	1.66	16.00	1.65	17.80	1.97	19.70	2.20
	23	10.50	1.02	12.30	1.29	14.10	1.59	14.80	1.70	16.00	1.69	17.80	2.02	19.70	2.26
	25	10.50	1.07	12.30	1.35	14.10	1.67	14.80	1.79	16.00	1.78	17.80	2.13	19.70	2.37
	27	10.50	1.10	12.30	1.39	14.10	1.72	14.80	1.85	16.00	1.84	17.80	2.20	19.70	2.45
	29	10.50	1.19	12.30	1.51	14.10	1.87	14.80	2.00	16.00	1.99	17.80	2.38	19.70	2.66
	31	10.50	1.29	12.30	1.63	14.10	2.02	14.80	2.16	16.00	2.15	17.80	2.57	19.60	2.87
	33	10.50	1.38	12.30	1.75	14.10	2.17	14.80	2.32	16.00	2.31	17.80	2.76	19.40	3.08
	35	10.50	1.47	12.30	1.87	14.10	2.31	14.80	2.47	16.00	2.46	17.80	2.94	19.10	3.28
	37	10.30	1.52	12.10	1.93	13.90	2.38	14.50	2.55	15.80	2.59	17.50	3.09	18.70	3.45
	39	10.10	1.55	11.80	1.96	13.60	2.42	14.20	2.59	15.40	2.69	17.10	3.21	18.30	3.58
	42	9.60	1.51	11.30	1.91	12.90	2.36	13.60	2.53	14.70	2.64	16.30	3.28	17.50	3.66
44	9.20	1.42	10.80	1.80	12.40	2.22	13.00	2.38	14.10	2.49	15.60	3.20	16.80	3.60	
50	10	8.90	0.63	10.40	0.80	12.00	0.99	12.60	1.06	13.60	1.05	15.40	1.29	16.60	1.44
	12	8.90	0.63	10.40	0.80	12.00	0.99	12.60	1.06	13.60	1.05	15.40	1.28	16.60	1.44
	14	8.90	0.63	10.40	0.80	12.00	0.99	12.60	1.06	13.60	1.06	15.40	1.29	16.60	1.45
	16	8.90	0.65	10.40	0.82	12.00	1.01	12.60	1.08	13.60	1.08	15.40	1.32	16.60	1.47
	18	8.90	0.67	10.40	0.85	12.00	1.04	12.60	1.12	13.60	1.11	15.40	1.36	16.60	1.52
	20	8.90	0.70	10.40	0.88	12.00	1.09	12.60	1.17	13.60	1.17	15.40	1.42	16.60	1.59
	21	8.90	0.72	10.40	0.91	12.00	1.12	12.60	1.20	13.60	1.19	15.40	1.46	16.60	1.63
	23	8.90	0.73	10.40	0.92	12.00	1.14	12.60	1.22	13.60	1.21	15.40	1.48	16.60	1.66
	25	8.90	0.76	10.40	0.97	12.00	1.19	12.60	1.28	13.60	1.27	15.40	1.55	16.60	1.74
	27	8.90	0.79	10.40	1.00	12.00	1.23	12.60	1.32	13.60	1.31	15.40	1.61	16.60	1.80
	29	8.90	0.85	10.40	1.08	12.00	1.34	12.60	1.43	13.60	1.42	15.40	1.74	16.60	1.95
	31	8.90	0.92	10.40	1.17	12.00	1.44	12.60	1.55	13.60	1.54	15.40	1.88	16.60	2.10
	33	8.90	0.99	10.40	1.25	12.00	1.55	12.60	1.66	13.60	1.65	15.40	2.02	16.60	2.26
	35	8.90	1.05	10.40	1.34	12.00	1.65	12.60	1.77	13.60	1.76	15.40	2.15	16.50	2.40
	37	8.70	1.09	10.30	1.38	11.80	1.71	12.30	1.83	13.40	1.85	15.10	2.26	16.20	2.53
	39	8.50	1.11	10.00	1.40	11.50	1.73	12.10	1.85	13.10	1.92	14.80	2.35	15.80	2.63
	42	8.20	1.08	9.60	1.37	11.00	1.69	11.50	1.81	12.50	1.89	14.10	2.40	15.10	2.68
44	7.80	1.02	9.20	1.29	10.50	1.59	11.00	1.70	12.00	1.78	13.50	2.36	14.50	2.64	

Capacity table

AM090FXMDGH/EU

Heating

TC : Total Capacity, PI : Power Input

Combination, % (Capacity index)	Outdoor Temperature (°C)		Indoor Temperature (°C, DB)									
			16		18		20		22		24	
			TC	PI	TC	PI	TC	PI	TC	PI	TC	PI
	DB	WB	kW		kW		kW		kW		kW	
130	-20	-21	18.00	5.37	17.70	5.42	17.20	5.48	17.00	5.58	16.70	5.69
	-17	-18	19.50	5.46	19.20	5.51	18.70	5.56	18.40	5.67	18.20	5.78
	-15	-16	21.10	5.53	20.80	5.58	20.20	5.64	20.00	5.75	19.70	5.86
	-12	-13	22.70	5.57	22.30	5.62	21.70	5.68	21.40	5.79	21.10	5.89
	-10	-11	24.20	5.61	23.80	5.66	23.10	5.72	22.80	5.83	22.50	5.94
	-7	-8	25.40	5.62	25.00	5.68	24.20	5.73	23.90	5.85	23.60	5.96
	-5	-6	26.70	5.10	26.30	5.15	25.50	5.20	25.20	5.30	24.90	5.40
	-3	-4	27.50	5.15	27.10	5.20	26.30	5.25	26.00	5.35	25.60	5.45
	0	-1	28.30	4.67	27.90	4.72	27.10	4.76	26.70	4.85	26.40	4.95
	3	2	29.20	4.77	28.70	4.81	27.90	4.86	27.50	4.95	27.20	5.05
	5	4	30.50	4.86	30.00	4.91	29.10	4.96	28.80	5.05	28.40	5.15
	7	6	31.10	4.96	30.70	5.01	29.70	5.05	29.40	5.15	29.00	5.25
	9	8	32.00	5.00	31.50	5.05	30.60	5.10	30.20	5.20	29.80	5.30
	11	10	32.90	5.05	32.40	5.10	31.40	5.15	31.10	5.25	30.70	5.35
	13	12	33.80	5.09	33.30	5.14	32.30	5.19	31.90	5.29	31.50	5.39
15	14	34.70	5.20	34.20	5.25	33.00	5.28	32.60	5.38	32.20	5.48	
120	-20	-21	17.80	5.51	17.20	5.56	16.90	5.62	16.60	5.73	16.40	5.83
	-17	-18	19.40	5.60	18.70	5.65	18.30	5.71	18.10	5.82	17.90	5.93
	-15	-16	21.00	5.67	20.20	5.73	19.80	5.78	19.60	5.90	19.30	6.01
	-12	-13	22.50	5.71	21.70	5.77	21.30	5.82	21.00	5.93	20.70	6.05
	-10	-11	24.00	5.75	23.10	5.81	22.70	5.87	22.40	5.98	22.10	6.09
	-7	-8	25.20	5.77	24.30	5.83	23.80	5.88	23.50	6.00	23.20	6.11
	-5	-6	26.50	5.23	25.50	5.28	25.00	5.33	24.70	5.44	24.40	5.54
	-3	-4	27.30	5.28	26.30	5.33	25.80	5.38	25.50	5.49	25.20	5.59
	0	-1	28.10	4.79	27.10	4.84	26.60	4.89	26.30	4.98	25.90	5.07
	3	2	28.90	4.89	27.90	4.94	27.40	4.99	27.00	5.08	26.70	5.18
	5	4	30.20	4.99	29.20	5.04	28.60	5.08	28.20	5.18	27.90	5.28
	7	6	30.90	5.09	29.80	5.14	29.20	5.18	29.10	5.28	28.80	5.38
	9	8	31.40	5.12	30.90	5.17	30.60	5.22	30.20	5.32	29.90	5.42
	11	10	32.30	5.18	31.20	5.23	31.50	5.28	31.10	5.38	30.70	5.49
	13	12	33.20	5.29	32.00	5.34	31.60	5.28	31.20	5.38	30.90	5.48
15	14	33.40	5.27	32.20	5.32	31.60	5.22	31.20	5.32	30.90	5.42	
110	-20	-21	17.70	5.64	16.90	5.70	16.10	5.75	15.90	5.86	15.70	5.97
	-17	-18	19.30	5.73	18.40	5.79	17.50	5.84	17.20	5.96	17.00	6.07
	-15	-16	20.80	5.81	19.90	5.87	18.90	5.92	18.70	6.04	18.40	6.15
	-12	-13	22.30	5.85	21.30	5.91	20.20	5.96	20.00	6.08	19.70	6.19
	-10	-11	23.80	5.89	22.70	5.95	21.60	6.01	21.30	6.12	21.10	6.24
	-7	-8	25.00	5.91	23.80	5.97	22.70	6.02	22.40	6.14	22.10	6.26
	-5	-6	26.30	5.36	25.10	5.41	23.90	5.46	23.60	5.57	23.30	5.67
	-3	-4	27.10	5.41	25.90	5.46	24.60	5.51	24.30	5.62	24.00	5.73
	0	-1	27.60	4.91	26.60	4.95	25.30	5.00	25.00	5.10	24.70	5.19
	3	2	28.20	5.01	27.40	5.06	26.10	5.11	25.80	5.20	25.40	5.30
	5	4	29.40	5.11	28.70	5.16	27.20	5.21	26.90	5.31	26.60	5.41
	7	6	30.10	5.21	29.30	5.26	27.80	5.30	27.50	5.41	27.10	5.51
	9	8	30.60	5.30	30.10	5.25	28.40	5.25	28.00	5.35	27.70	5.45
	11	10	31.50	5.31	30.10	5.12	28.40	5.12	28.00	5.22	27.70	5.32
	13	12	31.90	5.27	30.10	4.98	28.40	4.98	28.00	5.08	27.70	5.17
15	14	31.90	5.22	30.10	4.85	28.40	4.84	28.00	4.94	27.70	5.03	
100	-20	-21	17.60	5.91	16.60	5.97	15.60	6.02	15.40	6.14	15.20	6.26
	-17	-18	19.10	6.00	18.00	6.06	17.00	6.12	16.80	6.24	16.60	6.36
	-15	-16	20.70	6.08	19.50	6.14	18.40	6.20	18.10	6.32	17.90	6.44
	-12	-13	22.10	6.12	20.90	6.18	19.70	6.24	19.40	6.36	19.20	6.48
	-10	-11	23.60	6.17	22.30	6.23	21.00	6.29	20.70	6.41	20.50	6.53
	-7	-8	24.80	6.19	23.40	6.25	22.00	6.31	21.80	6.43	21.50	6.55
	-5	-6	26.10	5.61	24.70	5.66	23.20	5.72	22.90	5.83	22.60	5.94
	-3	-4	26.90	5.66	25.40	5.72	23.90	5.77	23.60	5.88	23.30	6.00
	0	-1	27.70	5.14	26.20	5.19	24.60	5.24	24.30	5.34	24.00	5.44
	3	2	28.50	5.24	26.90	5.29	25.40	5.35	25.00	5.45	24.70	5.55
	5	4	29.30	5.25	27.60	5.30	26.00	5.35	25.70	5.45	25.30	5.56
	7	6	29.30	5.24	27.60	5.29	26.00	5.34	25.70	5.44	25.30	5.55
	9	8	29.30	5.15	27.60	5.20	26.00	5.25	25.70	5.35	25.30	5.45
	11	10	29.30	5.11	27.60	5.01	26.00	5.06	25.70	5.15	25.30	5.25
	13	12	29.30	4.92	27.60	4.83	26.00	4.87	25.70	4.97	25.30	5.06
15	14	29.30	4.88	27.60	4.65	26.00	4.70	25.70	4.79	25.30	4.88	
90	-20	-21	16.70	5.91	16.20	5.97	15.50	6.02	15.30	6.14	15.10	6.26
	-17	-18	18.10	6.00	17.60	6.06	16.90	6.12	16.70	6.24	16.50	6.36
	-15	-16	19.60	6.08	19.00	6.14	18.30	6.20	18.00	6.32	17.80	6.44
	-12	-13	21.00	6.12	20.40	6.18	19.60	6.24	19.30	6.36	19.10	6.48
	-10	-11	22.40	6.17	21.80	6.23	20.90	6.29	20.60	6.41	20.40	6.53
	-7	-8	23.60	6.19	22.80	6.25	21.90	6.31	21.70	6.43	21.40	6.55
	-5	-6	24.80	5.61	24.00	5.66	23.10	5.72	22.80	5.83	22.50	5.94
	-3	-4	25.60	5.66	24.80	5.72	23.60	5.73	23.30	5.84	23.00	5.95
	0	-1	26.30	5.14	25.10	5.10	23.60	5.04	23.30	5.14	23.00	5.24
	3	2	26.50	5.13	25.10	5.05	23.60	5.00	23.30	5.10	23.00	5.19
	5	4	26.50	5.01	25.10	4.93	23.60	4.88	23.30	4.98	23.00	5.07
	7	6	26.50	5.00	25.10	4.92	23.60	4.87	23.30	4.97	23.00	5.06
	9	8	26.50	4.92	25.10	4.84	23.60	4.79	23.30	4.88	23.00	4.97
	11	10	26.50	4.74	25.10	4.66	23.60	4.61	23.30	4.70	23.00	4.79
	13	12	26.50	4.57	25.10	4.49	23.60	4.45	23.30	4.53	23.00	4.62
15	14	26.50	4.40	25.10	4.33	23.60	4.28	23.30	4.37	23.00	4.45	
80	-20	-21	16.50	5.84	16.00	5.89	15.40	5.95	15.20	6.07	15.00	6.18
	-17	-18	17.90	5.93	17.40	5.99	16.70	6.05	16.50	6.16	16.30	6.28
	-15	-16	19.40	6.01	18.90	6.07	18.10	6.13	17.90	6.24	17.70	6.36
	-12	-13	20.70	6.05	20.20	6.11	19.40	6.17	19.20	6.29	18.90	6.40
	-10	-11	22.10	6.09	21.60	6.15	20.70	6.21	20.40	6.33	20.20	6.45
	-7	-8	23.20	6.11	22.30	6.07	20.90	6.01	20.70	6.12	20.40	6.24
	-5	-6	23.60	5.34	22.30	5.23	20.90	5.17	20.70	5.27	20.40	5.37
	-3	-4	23.60	5.23	22.30	5.12	20.90	5.07	20.70	5.16	20.40	5.26
	0	-1	23.60	4.61	22.30	4.51	20.90	4.46	20.70	4.55	20.40	4.63
	3	2	23.60	4.57	22.30	4.47	20.90	4.42	20.70	4.51	20.40	4.59

Capacity table

AM090FXMDGH/EU

Heating

TC : Total Capacity, PI : Power Input

Combination, % (Capacity index)	Outdoor Temperature (°C)		Indoor Temperature (°C, DB)									
			16		18		20		22		24	
			TC	PI	TC	PI	TC	PI	TC	PI	TC	PI
	DB	WB	kW		kW		kW		kW		kW	
80	5	4	23.60	4.46	22.30	4.37	20.90	4.32	20.70	4.40	20.40	4.49
	7	6	23.60	4.45	22.30	4.36	20.90	4.31	20.70	4.39	20.40	4.48
	9	8	23.60	4.37	22.30	4.28	20.90	4.23	20.70	4.32	20.40	4.40
	11	10	23.60	4.21	22.30	4.13	20.90	4.08	20.70	4.16	20.40	4.24
	13	12	23.60	4.06	22.30	3.98	20.90	3.93	20.70	4.01	20.40	4.09
	15	14	23.60	3.91	22.30	3.83	20.90	3.79	20.70	3.86	20.40	3.94
70	-20	-21	16.50	5.63	15.70	5.68	15.10	5.74	14.90	5.85	14.70	5.96
	-17	-18	17.90	5.72	17.10	5.78	16.40	5.83	16.20	5.94	16.00	6.06
	-15	-16	19.40	5.80	18.50	5.85	17.80	5.91	17.60	6.02	17.30	6.14
	-12	-13	20.60	5.78	19.50	5.78	18.30	5.72	18.10	5.83	17.90	5.94
	-10	-11	20.60	5.45	19.50	5.45	18.30	5.39	18.10	5.50	17.90	5.60
	-7	-8	20.60	5.22	19.50	5.22	18.30	5.16	18.10	5.26	17.90	5.36
	-5	-6	20.60	4.50	19.50	4.49	18.30	4.45	18.10	4.53	17.90	4.62
	-3	-4	20.60	4.40	19.50	4.40	18.30	4.35	18.10	4.44	17.90	4.52
	0	-1	20.60	3.88	19.50	3.88	18.30	3.84	18.10	3.91	17.90	3.98
	3	2	20.60	3.84	19.50	3.84	18.30	3.80	18.10	3.87	17.90	3.95
	5	4	20.60	3.75	19.50	3.75	18.30	3.71	18.10	3.78	17.90	3.85
	7	6	20.60	3.75	19.50	3.74	18.30	3.70	18.10	3.78	17.90	3.85
	9	8	20.60	3.68	19.50	3.68	18.30	3.64	18.10	3.71	17.90	3.78
	11	10	20.60	3.55	19.50	3.54	18.30	3.51	18.10	3.58	17.90	3.64
	13	12	20.60	3.42	19.50	3.42	18.30	3.38	18.10	3.45	17.90	3.51
15	14	20.60	3.29	19.50	3.29	18.30	3.26	18.10	3.32	17.90	3.38	
60	-20	-21	15.80	5.28	14.90	5.33	14.00	5.38	13.90	5.48	13.70	5.59
	-17	-18	17.20	5.36	16.20	5.41	15.30	5.47	15.10	5.57	14.90	5.68
	-15	-16	17.70	5.17	16.70	5.22	15.70	5.27	15.50	5.37	15.30	5.47
	-12	-13	17.70	4.86	16.70	4.90	15.70	4.95	15.50	5.05	15.30	5.14
	-10	-11	17.70	4.58	16.70	4.62	15.70	4.67	15.50	4.76	15.30	4.85
	-7	-8	17.70	4.38	16.70	4.43	15.70	4.47	15.50	4.55	15.30	4.64
	-5	-6	17.70	3.78	16.70	3.81	15.70	3.85	15.50	3.92	15.30	4.00
	-3	-4	17.70	3.70	16.70	3.73	15.70	3.77	15.50	3.84	15.30	3.92
	0	-1	17.70	3.26	16.70	3.29	15.70	3.32	15.50	3.38	15.30	3.45
	3	2	17.70	3.23	16.70	3.26	15.70	3.29	15.50	3.35	15.30	3.42
	5	4	17.70	3.15	16.70	3.18	15.70	3.21	15.50	3.28	15.30	3.34
	7	6	17.70	3.15	16.70	3.18	15.70	3.21	15.50	3.27	15.30	3.33
	9	8	17.70	3.09	16.70	3.12	15.70	3.15	15.50	3.21	15.30	3.27
	11	10	17.70	2.98	16.70	3.01	15.70	3.04	15.50	3.10	15.30	3.15
	13	12	17.70	2.87	16.70	2.90	15.70	2.93	15.50	2.98	15.30	3.04
15	14	17.70	2.77	16.70	2.79	15.70	2.82	15.50	2.87	15.30	2.93	
50	-20	-21	14.20	4.68	13.40	4.73	12.60	4.77	12.50	4.86	12.30	4.96
	-17	-18	14.60	4.50	13.80	4.54	13.00	4.58	12.80	4.67	12.70	4.76
	-15	-16	14.60	4.21	13.80	4.25	13.00	4.29	12.80	4.37	12.70	4.46
	-12	-13	14.60	3.96	13.80	3.99	13.00	4.03	12.80	4.11	12.70	4.19
	-10	-11	14.60	3.73	13.80	3.77	13.00	3.80	12.80	3.88	12.70	3.95
	-7	-8	14.60	3.57	13.80	3.60	13.00	3.64	12.80	3.71	12.70	3.78
	-5	-6	14.60	3.07	13.80	3.10	13.00	3.13	12.80	3.20	12.70	3.26
	-3	-4	14.60	3.01	13.80	3.04	13.00	3.07	12.80	3.13	12.70	3.19
	0	-1	14.60	2.65	13.80	2.68	13.00	2.70	12.80	2.76	12.70	2.81
	3	2	14.60	2.63	13.80	2.65	13.00	2.68	12.80	2.73	12.70	2.78
	5	4	14.60	2.57	13.80	2.59	13.00	2.62	12.80	2.67	12.70	2.72
	7	6	14.60	2.56	13.80	2.59	13.00	2.61	12.80	2.66	12.70	2.71
	9	8	14.60	2.52	13.80	2.54	13.00	2.57	12.80	2.62	12.70	2.66
	11	10	14.60	2.43	13.80	2.45	13.00	2.47	12.80	2.52	12.70	2.57
	13	12	14.60	2.34	13.80	2.36	13.00	2.38	12.80	2.43	12.70	2.48
15	14	14.60	2.25	13.80	2.27	13.00	2.30	12.80	2.34	12.70	2.39	

Capacity correction

OUTDOOR

AM080FXMDGH/EU

Cooling

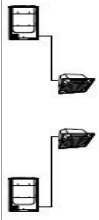

Level Difference (m)	Pipe Length (m)													
	8	10	20	30	40	50	60	70	80	90	100	110	120	130
50	-	-	-	-	-	0.93	0.92	0.91	0.89	0.89	0.88	0.87	0.86	0.85
40	-	-	-	-	0.95	0.93	0.92	0.91	0.89	0.90	0.88	0.87	0.86	0.85
30	-	-	-	0.96	0.95	0.94	0.92	0.91	0.90	0.90	0.89	0.87	0.86	0.85
20	-	-	0.98	0.97	0.95	0.94	0.92	0.91	0.90	0.90	0.89	0.88	0.87	0.85
10	-	0.99	0.98	0.97	0.95	0.94	0.93	0.91	0.90	0.90	0.89	0.88	0.87	0.86
0	1.00	1.00	0.98	0.97	0.96	0.94	0.93	0.92	0.90	0.90	0.89	0.88	0.87	0.86
-10	-	1.00	0.98	0.97	0.96	0.94	0.93	0.92	0.90	0.91	0.89	0.88	0.87	0.86
-20	-	-	0.99	0.97	0.96	0.95	0.93	0.92	0.91	0.91	0.90	0.88	0.87	0.86
-30	-	-	-	0.98	0.96	0.95	0.93	0.92	0.91	0.91	0.90	0.89	0.88	0.86
-40	-	-	-	-	0.96	0.95	0.94	0.92	0.91	0.91	0.90	0.89	0.88	0.87

Heating



Level Difference (m)	Pipe Length (m)													
	8	10	20	30	40	50	60	70	80	90	100	110	120	130
50	-	-	-	-	-	0.97	0.96	0.95	0.95	0.95	0.94	0.94	0.93	0.93
40	-	-	-	-	0.97	0.97	0.96	0.95	0.95	0.95	0.94	0.94	0.93	0.93
30	-	-	-	0.98	0.97	0.97	0.96	0.95	0.95	0.95	0.94	0.94	0.93	0.93
20	-	-	0.99	0.98	0.97	0.97	0.96	0.95	0.95	0.95	0.94	0.94	0.93	0.93
10	-	0.99	0.99	0.98	0.97	0.97	0.96	0.95	0.95	0.95	0.94	0.94	0.93	0.93
0	1.00	0.99	0.99	0.98	0.97	0.97	0.96	0.95	0.95	0.95	0.94	0.94	0.93	0.93
-10	-	0.99	0.99	0.98	0.97	0.97	0.96	0.95	0.95	0.95	0.94	0.94	0.93	0.93
-20	-	-	0.99	0.98	0.97	0.97	0.96	0.95	0.95	0.95	0.94	0.94	0.93	0.93
-30	-	-	-	0.98	0.97	0.97	0.96	0.95	0.95	0.95	0.94	0.94	0.93	0.93
-40	-	-	-	-	0.97	0.97	0.96	0.95	0.95	0.95	0.94	0.94	0.93	0.93

AM090FXMDGH/EU

Cooling

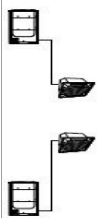

Level Difference (m)	Pipe Length (m)													
	8	10	20	30	40	50	60	70	80	90	100	110	120	130
50	-	-	-	-	-	0.93	0.92	0.91	0.89	0.89	0.88	0.87	0.86	0.85
40	-	-	-	-	0.95	0.93	0.92	0.91	0.89	0.90	0.88	0.87	0.86	0.85
30	-	-	-	0.96	0.95	0.94	0.92	0.91	0.90	0.90	0.89	0.87	0.86	0.85
20	-	-	0.98	0.97	0.95	0.94	0.92	0.91	0.90	0.90	0.89	0.88	0.87	0.85
10	-	0.99	0.98	0.97	0.95	0.94	0.93	0.91	0.90	0.90	0.89	0.88	0.87	0.86
0	1.00	1.00	0.98	0.97	0.96	0.94	0.93	0.92	0.90	0.90	0.89	0.88	0.87	0.86
-10	-	1.00	0.98	0.97	0.96	0.94	0.93	0.92	0.90	0.91	0.89	0.88	0.87	0.86
-20	-	-	0.99	0.97	0.96	0.95	0.93	0.92	0.91	0.91	0.90	0.88	0.87	0.86
-30	-	-	-	0.98	0.96	0.95	0.93	0.92	0.91	0.91	0.90	0.89	0.88	0.86
-40	-	-	-	-	0.96	0.95	0.94	0.92	0.91	0.91	0.90	0.89	0.88	0.87

Heating

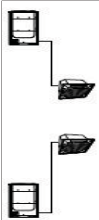

Level Difference (m)	Pipe Length (m)													
	8	10	20	30	40	50	60	70	80	90	100	110	120	130
50	-	-	-	-	-	0.97	0.96	0.95	0.95	0.95	0.94	0.94	0.93	0.93
40	-	-	-	-	0.97	0.97	0.96	0.95	0.95	0.95	0.94	0.94	0.93	0.93
30	-	-	-	0.98	0.97	0.97	0.96	0.95	0.95	0.95	0.94	0.94	0.93	0.93
20	-	-	0.99	0.98	0.97	0.97	0.96	0.95	0.95	0.95	0.94	0.94	0.93	0.93
10	-	0.99	0.99	0.98	0.97	0.97	0.96	0.95	0.95	0.95	0.94	0.94	0.93	0.93
0	1.00	0.99	0.99	0.98	0.97	0.97	0.96	0.95	0.95	0.95	0.94	0.94	0.93	0.93
-10	-	0.99	0.99	0.98	0.97	0.97	0.96	0.95	0.95	0.95	0.94	0.94	0.93	0.93
-20	-	-	0.99	0.98	0.97	0.97	0.96	0.95	0.95	0.95	0.94	0.94	0.93	0.93
-30	-	-	-	0.98	0.97	0.97	0.96	0.95	0.95	0.95	0.94	0.94	0.93	0.93
-40	-	-	-	-	0.97	0.97	0.96	0.95	0.95	0.95	0.94	0.94	0.93	0.93



Samsung Electronics Co., LTD.
Airconditioner Marketing Group/SE

Head Office (Suwon Korea) 416, Maetan-3Dong, Yeongtong-Gu, Suwon City, Gyeonggi-Do, Korea 443-742

TEL : 82-31-200-4549 Website : www.dvmsystem.com Email: airconditioner@samsung.com

Images and data in this book may subject to change without prior notice.